

# KANKARE

STONE

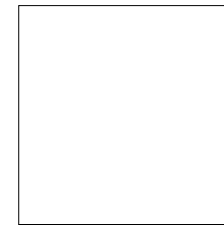

## FORMATS.FORMATI.FORMATOS



**90X90**  
89,46x89,46 cm - 35.22"x35.22"



**45X90**  
44,63x89,46 cm - 17.61"x35.22"

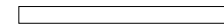

**7,5X90**  
7,3x89,46 cm - 2.87"x35.22"

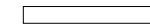

**7,5X45**  
7,3x44,63 cm - 2.87"x17.61"

## COLOURS COLORI COLORES



Ivory



Grey



Vison

## SPECIAL PIECES.PEZZI SPECIALI.PIEZAS ESPECIALES

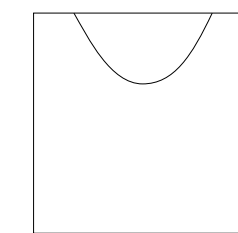

**90X90 Bag\***  
89,46x89,46 cm - 35.22"x35.22"  
**45X90 Bag\***  
44,63 x 89,46 cm - 17.57" x 35.22"

+ INFO pag. 224

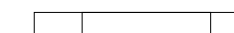

**22X90 UP**  
22,21x88,80 cm - 8.74"x34.96"



**30X30 mosaico 5x5**  
29,75x29,75 cm - 11.71"x11.71"



**45X90 Lines**  
44,63x89,46 cm - 17.61"x35.22"

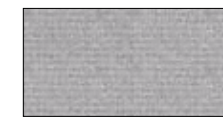

**45X90 Rubic**  
44,63x89,46 cm - 17.61"x35.22"



**15X90 Chevron**  
14,77x89,46 cm - 17.61"x35.22"

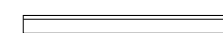

**7,5X90 rodapié**  
7,3x89,46 cm - 2.87"x35.22"



**7,5X45 rodapié**  
7,3x44,63 cm - 2.87" x 17.61"

## FINISHES FINITURI ACABADOS



Natural

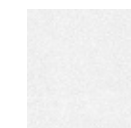

Non-slip

## THICKNESS.SPESSORE.ESPESORES

± 0,74 cm / 0,27" approx.

# KANKARE IVORY

non-slip **CLASE 3** **R10\*\*** natural **CLASE 1** **R9** **DCOF>0.42**  
UNE - ENV 12633 DIN 51130 UNE - ENV 12633 DIN 51130 ANSI A 137.1 - 2012

## BASE TILES.BASE.BASES



**Kankare ivory natural**  
 89,46x89,46 cm - 35.22"x35.22"  
**G-6372**



**Kankare ivory natural / Kankare ivory non-slip**  
 44,63x89,46 cm - 17.57"x35.22"  
**G-6224 / G-6246**



**Kankare ivory cenefa 3 natural**  
 14,70x89,46 cm - 5.90"x35.22"  
**G-6330**

## SPECIAL PIECES.PEZZI SPECIALI. PIEZAS ESPECIALES



**Kankare ivory lines natural**  
 44,63x89,46 cm - 17.57"x35.22"  
**G-6250**



**Kankare ivory rubic natural\***  
 44,63x89,46 cm - 17.57"x35.22"  
**G-6250**



**Kankare ivory natural rodapié 90**  
 7,3x89,46 cm - 2.87"x35.22"  
**G-5125**



**Kankare ivory natural rodapié 45**  
 7,3x44,63 cm - 2.87"x23.45"  
**G-5085**

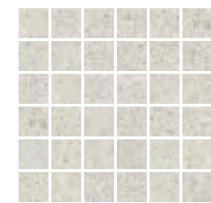

**Kankare ivory natural mosaico 5x5**  
 29,75x29,75 cm - 11.71"x11.71"  
**G-6644**

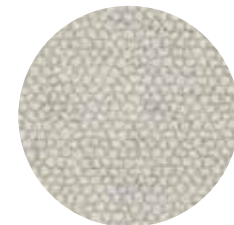

\* **DETAIL.** Kankare ivory rubic natural  
 \* **DETALLE.** Kankare ivory rubic natural



KANKARE

Kankare ivory natural 89,46x89,46 cm

\*\* For projects check technical information with our commercial network.  
 \*\*Per i progetti ottenere informazioni tecniche attraverso la nostra rete commerciale.  
 \*\* Para proyectos obtenga información técnica a través de nuestra red comercial.

# KANKARE GREY

natural **CLASE 1** **R9** **DCOF>0.42**  
UNE - ENV 12633 DIN 51130 ANSI A 137.1 - 2012

## BASE TILES.BASE.BASES



**Kankare grey natural**  
 89,46x89,46 cm - 35.22"x35.22"  
**G-6372**



**Kankare grey natural**  
 44,63x89,46 cm - 17.57"x35.22"  
**G-6224**



**Kankare grey cenefa 3 natural**  
 14,70x89,46 cm - 5.90"x35.22"  
**G-6330**

## SPECIAL PIECES.PEZZI SPECIALI. PIEZAS ESPECIALES



**Kankare grey lines natural**  
 44,63x89,46 cm - 17.57"x35.22"  
**G-6250**



**Kankare grey rubic natural\***  
 44,63x89,46 cm - 17.57"x35.22"  
**G-6250**



**Kankare grey natural rodapié 90**  
 7,3x89,46 cm - 2.87"x35.22"  
**G-5125**



**Kankare grey natural rodapié 45**  
 7,3x44,63 cm - 2.87"x23.45"  
**G-5085**

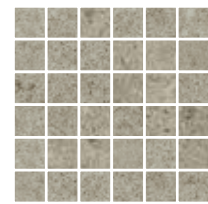

**Kankare grey natural mosaico 5x5**  
 29,75x29,75 cm - 11.71"x11.71"  
**G-6644**

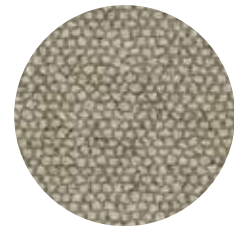

\* DETAIL. Kankare grey rubic natural  
 \* DETALLE. Kankare grey rubic natural

\*\* For projects check technical information with our commercial network.  
 \*\*Per i progetti ottenere informazioni tecniche attraverso la nostra rete commerciale.  
 \*\* Para proyectos obtenga información técnica a través de nuestra red comercial.



**KANKARE**

Wall: Kankare ivory lines 89,46x89,46 cm  
 Floor: Kankare grey natural 89,46x89,46 cm

# KANKARE VISON

natural **CLASE 1** **R9** **DCOF>0.42**  
 UNE - ENV 12633 DIN 51130 ANSI A 137.1 - 2012

BASE TILES.BASE.BASES



**Kankare vison natural**  
 89,46x89,46 cm - 35.22"x35.22"  
 G-6372



**Kankare vison natural**  
 44,63x89,46 cm - 17.57"x35.22"  
 G-6224



**Kankare vison cenefa 3 natural**  
 14,70x89,46 cm - 5.90"x35.22"  
 G-6330

SPECIAL PIECES.PEZZI SPECIALI.  
 PIEZAS ESPECIALES



**Kankare vison lines natural**  
 44,63x89,46 cm - 17.57"x35.22"  
 G-6250

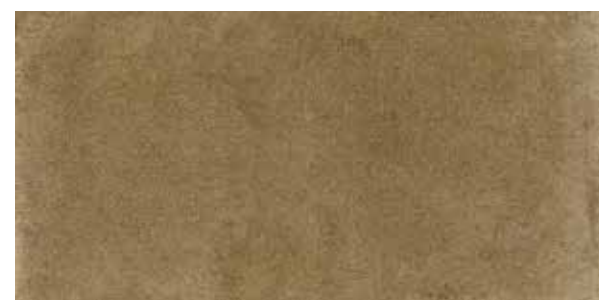

**Kankare vison rubic natural\***  
 44,63x89,46 cm - 17.57"x35.22"  
 G-6250



**Kankare vison natural rodapié 90**  
 7,3x89,46 cm - 2.87"x35.22"  
 G-5125



**Kankare vison natural rodapié 45**  
 7,3x44,63 cm - 2.87"x23.45"  
 G-5085

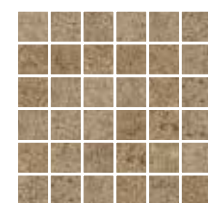

**Kankare vison natural mosaico 5x5**  
 29,75x29,75 cm - 11.71"x11.71"  
 G-6644

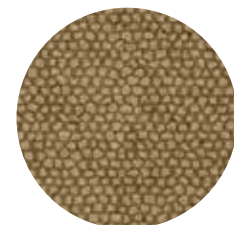

\* DETAIL. Kankare vison rubic natural  
 \* DETALLE. Kankare vison rubic natural

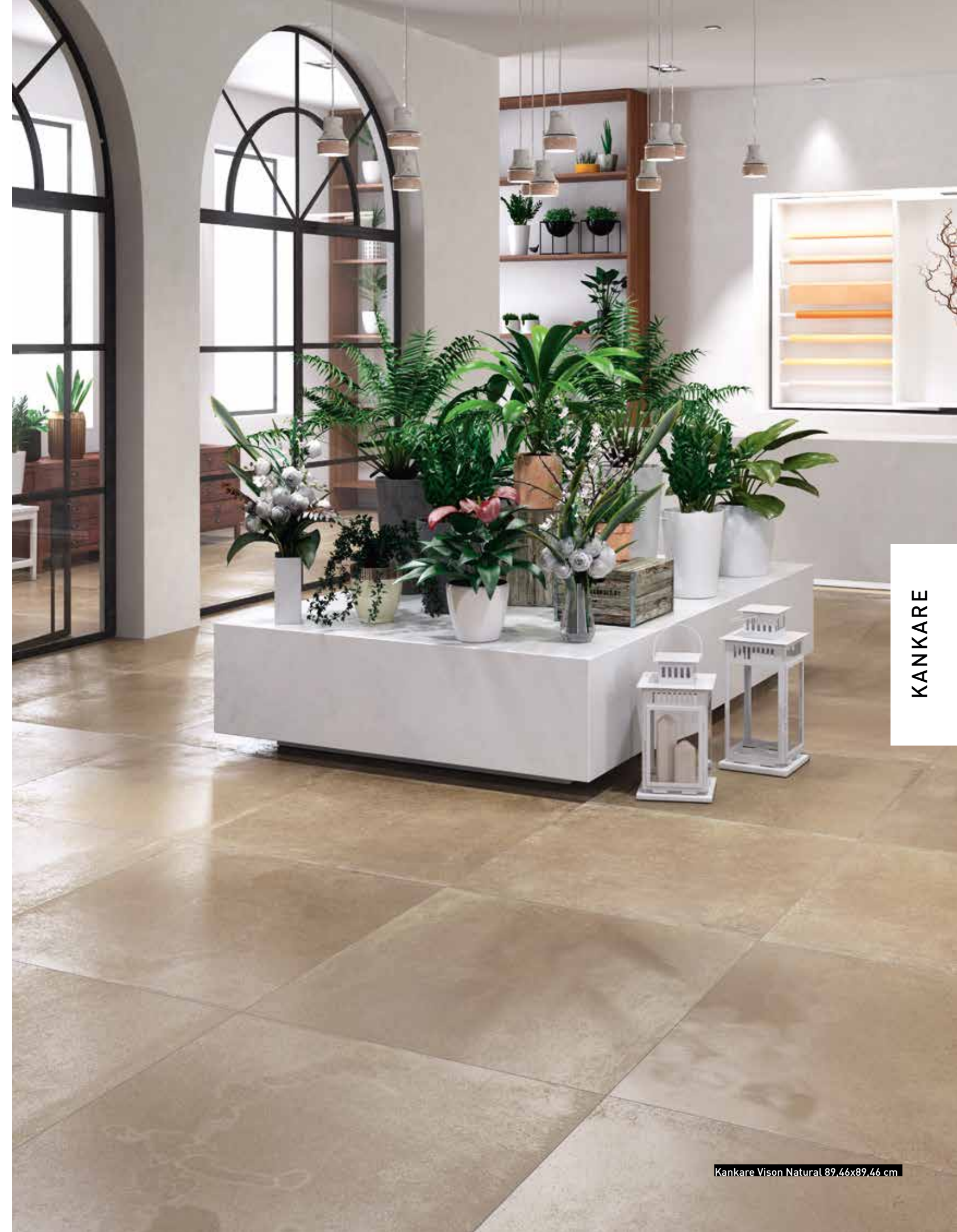

KANKARE

Kankare Vison Natural 89,46x89,46 cm

\*\* For projects check technical information with our commercial network.  
 \*\*Per i progetti ottenere informazioni tecniche attraverso la nostra rete commerciale.  
 \*\* Para proyectos obtenga información técnica a través de nuestra red comercial.

# KANKARE

natural

CLASE 1  
UNE - ENV 12633

R9\*\*  
DIN 51130

DCOF>0.42  
ANSI A 137.1 - 2012

## SPECIAL PIECES. PEZZI SPECIALI. PIEZAS ESPECIALES



**Conjunto Kankare ivory & vison natural mosaico 3D\***  
44,63x44,63 cm - 17.57"x17.57"  
G-6756\*\*



**Kankare ivory & vison natural hexagon 3D**  
18,29x31,56 cm - 7.20"x12.42"

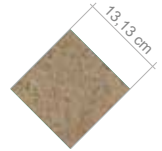

**Taco Kankare vison natural mosaico 3D**  
13,13x13,13 cm - 5.17"x5.17"

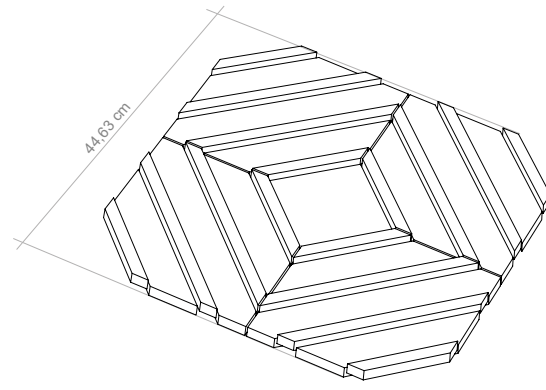

\*5 PIECE COMPOSITION.  
4xKankare hexagon 3D + 1xKankare taco. An additional taco for composition (included in the box) is required to complete the tile composition on the wall.

\*COMPOSICIÓN DE 5 PIEZAS.  
4xKankare Hexagon Mos. 3D + 1xKankare Taco Mos. 3D. Un taco adicional por composición (incluido en la caja) es necesario para completar la composición del mosaico en pared.

\*\*BOX CONTENT: 4 sets, including: 16xKankare Hexagon Mos. 3D + 8xKankare Taco Mos. 3D.

\*\*CONTENIDO DE LA CAJA: 16xKankare Hexagon Mos. 3D + 8xKankare Taco Mos. 3D.



**Conjunto Kankare ivory & grey natural**  
44,63x44,63 cm - 17.57"x17.57"  
G-6756\*\*



**Kankare ivory & grey natural hexagon 3D**  
18,29x31,56 cm - 7.20"x12.42"

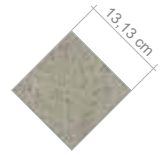

**Taco Kankare grey natural mosaico 3D**  
13,13x13,13 cm - 5.17"x5.17"



**Kankare vison chevron natural**  
14,70x89,46 cm - 5.90"x35.22"  
G-6594



**Kankare ivory chevron natural**  
14,70x89,46 cm - 5.90"x35.22"  
G-6594



**Kankare grey chevron natural**  
14,70x89,46 cm - 5.90"x35.22"  
G-6594

## COMPOSITIONS. COMPOSIZIONI. COMPOSICIONES



COMPOSITION. COMPOSICIÓN  
Kankare hexagon 3D  
Kankare taco



COMPOSITION. COMPOSICIÓN  
Kankare hexagon 3D  
Kankare taco



COMPOSITION. COMPOSICIÓN  
Kankare chevron ivory  
Kankare chevron grey  
Kankare chevron vison  
Pieces are sold separately. Las piezas se venden por separado

KANKARE

## STEPS. GRADINI. PELDAÑOS

		natural
SIMPLE		peldaño simple-45 (45x90 cm) 5305
		peldaño simple-90 (90x90 cm) 5585
		peldaño simple áng (45x90 cm) 5315
		peldaño simple áng (90x90 cm) 5609
GRADONE		peldaño grad-45 (45x90 cm) 5603
		peldaño grad-90 (90x90 cm) 5779
		peldaño grad. áng (45x90 cm) 5623
		peldaño grad. áng (90x90 cm) 5829

\*\* For projects check technical information with our commercial network.  
\*\* Per i progetti ottenere informazioni tecniche attraverso la nostra rete commerciale.  
\*\* Para proyectos obtenga información técnica a través de nuestra red comercial.

For more information, please contact our commercial department.  
Para más información, por favor, contacte con nuestro departamento comercial

## TECHNICAL CHARACTERISTICS.CARATTERISTICHE TECNICHE.CARACTERÍSTICAS TÉCNICAS

MEASUREMENTS AND SURFACES APPEARANCE DIMENSIONI E ASPETTO SUPERFICIALE MEDIDAS Y ASPECTO SUPERFICIAL	STANDARD TEST METHOD METODO DELLA NORMA MÉTODO DE ENSAYO	STANDARD PRESCRIBED VALUES VALORE PRESCRITTO VALORES STANDARD NORMA	KANKARE collection *
<b>Length and width.</b> Lunghezza e larghezza. Longitud y anchura. Länge und Breite	ISO 10545-2	± 0,6% max.	± 0,2%
<b>Orthogonality.</b> Ortogonalità. Ortogonalidad. Rechtwinkligkeit	ISO 10545-2	± 0,5% max.	± 0,2%
<b>Straightness of sides.</b> Rettilinearità dei lati. Rectitud de lados. Kantengeradigkeit	ISO 10545-2	± 0,5% max.	± 0,2%
<b>Surfaces flatness.</b> Planarità. Planitud. Ebenfächigkeit	ISO 10545-2	± 0,5% max.	± 0,2%

PHYSICAL PROPERTIES PROPIETÀ FISICHE PROPIEDADES FÍSICA			
<b>Water absorption.</b> Assorbimento d' acqua. Absorción de agua. Wasseraufnahme	ISO 10545-3	≤ 0,5%	< 0,1%
<b>Breaking strength, in N.</b> Carico di rottura, en N. Carga de rotura, en N. Bruchlast, in N	ISO 10545-4	≥ 700 N	> 1400 N
<b>Modulus of rupture</b> Resistenza alla flessione. Resistencia a la flexión. Biegefestigkeit	ISO 10545-4	≥ 35 N/mm <sup>2</sup>	>40 N/mm <sup>2</sup>
<b>Resistance to thermal shock.</b> Resistenza agli sbalzi termici. Resistencia al choque térmico. Temperaturwechselfähigkeit	ISO 10545-9	No surface defects should be visible Non deve presentare difetti visibili No debe presentar defectos superficiales visibles	Resistant. Resistente. Resistente
<b>Frost resistance.</b> Resistenza al gelo. Resistencia a la helada. Frostbeständigkeit	ISO 10545-12	No surface defects or cracks should be visible Non deve presentare difetti visibili No debe presentar defectos ni grietas superficiales visibles	Frost Resistant Antighaccio Resistente a la Helada
<b>Coefficient of friction.</b> Resistenza allo scivolamento. Coeficiente de fricción. Rutschfestigkeit	DIN 51130 UNE-ENV 12633 DCOF - ANSIA 137.1	-	R9 / R10 (natural / non-slip) Clase I * (natural) >0.42
<b>Colour resistance to light.</b> Resistenza dei colori alla luce. Resistencia del color a la luz. Lichtbeständigkeit der Farben	DIN 51094	There should be no colour variations Non deve presentare difetti visibili No debe presentar variaciones de color	No alterations in colour and shine Non presenta alterazioni di colori e lucentezza No presenta variaciones de color y brillo

CHEMICAL PROPERTIES PROPIETÀ CHIMICHE PROPIEDADES QUÍMICAS			
<b>Chemical resistance.</b> Resistenza agli agenti chimici. Resistencia química. Chemikalienbeständigkeit	ISO 10545-13	Resistance to household cleaning products and swimmingpools salts. Resistencia a productos domésticos y sales para piscinas.	Min. UB
<b>Resistance to staining.</b> Resistenza alle macchie. Resistencia a las manchas. Fleckenbeständigkeit	ISO 10545-14	Declared Value Valor Declarado	5

\* The Land values are the average of different production consignments. For further detail information, please check with our commercial network.  
Los valores declarados son el promedio obtenido a través de ensayos de diferentes producciones. Para la obtención de una información detallada consultar a la red comercial.  
For projects check technical information with our commercial networks. / Para proyectos obtenga información técnica a través de nuestra red comercial.



Kankare vison natural UP 22,21x89,46 cm

KANKARE

## SPECIAL PIECES.PEZZI SPECIALI. PIEZAS ESPECIALES

3Dimensional

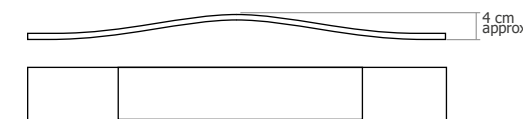

**UP**  
14,70x88,80 cm - 8.74" x35.22"

- Kankare Up 14,70x88,80 cm **G-5337**

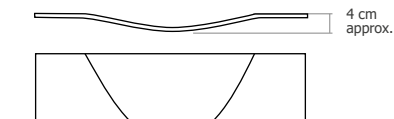

**BAG\***  
89,46x89,46 cm / 59,55x59,55 cm

- Kankare Bag 88,46x88,46 cm\* **G-5795**  
- Kankare Bag 44,63x89,46 cm\* **G-5599**

\* Available in all colours from Kankare collection.  
\* Disponible en todos los colores de la colección Kankare.

This is a natural product made through a handmade process, therefore, its possible shade or size variations must be considered as typical features of the material and they will not be admitted in a claim.  
Questo è un prodotto naturale fatto a mano, eventuali variazioni di tono o dimensione devono essere considerate normali per il materiale e non saranno oggetto di un reclamo.  
Este es un producto natural fabricado artesanalmente, por lo que posibles variaciones de tono o dimension deben considerarse propias del material y no será objeto de reclamación.