



EXTRA
ORDINARY SIZE

P R E Z I O S I



UNA GRANDE VERSATILITÀ PER OGNI CAMPO DI APPLICAZIONE

Great versatility in all fields of application
 Une grande polyvalence pour tout domaine d'application
 Eine grosse Vielseitigkeit für jeden Anwendungsbereich
 Una gran versatilidad para cada campo de aplicación
 Высокая универсальность в любой сфере применения
 在任何应用场合广泛的适用性

Con i grandi formati si possono realizzare tagli di qualunque forma e dimensione, per ampliare ulteriormente le possibilità di utilizzo della lastra andando dal pavimento per arrivare al rivestimento di pareti, mobili, tavoli, piani, ante.

With large sizes, you can make cuts of any shape and size, to further extend the possibilities of use of the slab covering floors, walls, furniture, tables and doors.

Avec les grands formats on peut réaliser des coupes de toute forme et toute dimension, pour élargir ultérieurement la gamme d'utilisations de la plaque, en partant du revêtement de sol pour arriver au revêtement de parois, meubles, tables, plans et portes.

Mit Großformaten sind beliebig große Schnitte in unterschiedlichsten Formen möglich und die Anwendungsmöglichkeiten der Platte werden noch umfangreicher, von Böden bis hin zur Verkleidung von Wänden, Möbeln, Tischen, Flächen und Türen.

Con los grandes formatos se pueden realizar cortes de cualquier forma y dimensión para ampliar ulteriormente las posibilidades de uso de la losa, que abarca desde el pavimento hasta llegar al revestimiento de paredes, muebles, mesas, superficies y puertas.

Из больших форматов всегда можно создавать меньшие форматы любых форм и размеров, все более расширяя возможности применения плиты: от пола до облицовки стен, мебели, поверхностей, створок.

采用大规格的板材，可以随意切割成各种形状和尺寸的板材，进一步扩大板材的应用范围，可应用在地板、墙面装饰、家具、桌面、平台和窗板。

WALL & FLOOR

PAVIMENTO E RIVESTIMENTO

Floor and covering. Revêtement sols et murs.
 Boden und Verkleidungen. Pavimento y revestimiento.
 Полы и облицовка. 地板及墙面。



CONTEMPORANEI / SKYLINE

FURNITURE AND DESIGN

TOP E RIVESTIMENTI COORDINATI

Coordinated top and covering. Top et revêtements coordonnés.
 Tops und koordinierte Verkleidungen. Encimeras y revestimientos coordinados.
 Комплекты столешниц и облицовок. 顶面及辅助装饰。



MARMI / CALACATTA

FURNITURE AND DESIGN

ARREDAMENTO E DESIGN

Furnishings. Ameublement.
 Einrichtung. Decoración.
 Оформление помещений. 装修。



CONTEMPORANEI / DISTRICT

FURNITURE AND DESIGN

PORTE E ANTE

Shutters and doors. Portes et battants.
 Türen und Schranktüren. Puertas y hojas.
 Двери и створки. 门和窗板。



MARMI / CALACATTA

BUSINESS TO BUSINESS

PISCINE

Swimming pools. Piscines.
 Schwimmbäder. Piscinas.
 Бассейны. 泳池。



MARMI / CALACATTA
 CONTEMPORANEI / SKYLINE

BUSINESS TO BUSINESS

CONTRACT

Контрактные поставки.
 协议。



CONTEMPORANEI / DISTRICT

BUSINESS TO BUSINESS

FACCIAE VENTILATE E INCOLLATE

Adhesive-mounted curtain walls. Façades ventilées et collées.
 Hinterlüftete und verklebte Fassaden. Fachadas ventiladas y encoladas.
 Вентилируемые и наклеенные фасады. 胶合通风外墙。



CONTEMPORANEI / SKYLINE

BUSINESS TO BUSINESS

INDUSTRIA NAVALE

Shipping industry. Industrie navale.
 Schiffbauindustrie. Industria naval.
 Кораблестроение. 船舶工业。



ONICI / AESTHETICA

EXTRA
ORDINARY SIZE

SHADE
SPECTRUM

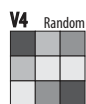
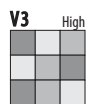
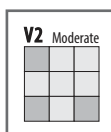

Spessore.
Thickness.
Epaisseur.
Stärke.
Espesor.
Толщина.
厚度.



100% DESIGN
AND PRODUCTION
OF ITALY

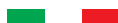

PREZIOSI NAUTILUS

LASTRE IN GRES PORCELLANATO PRESSATE A SECCO.

Dry-pressed porcelain stoneware slabs.

Dalles en grès cérame pressées à sec.

Trockengepresste Platten aus Feinsteinzeug.

Planchas en gres porcelánico prensadas en seco.

Керамогранитные плиты сухого прессования.

干压陶瓷砖.

Spessore. **6mm**

Thickness. Epaisseur. Stärke. Espesor. Толщина. 厚度.



320x160cm. 126"x63"
thickness 6mm



160x160cm. 63"x63"
thickness 6mm

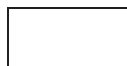

160x80cm. 63"x31 1/2"
thickness 6mm



80x80cm. 31 1/2"x31 1/2"
thickness 6mm



240x120cm. 96"x48"
thickness 6mm



120x120cm. 48"x48"
thickness 6mm

NAUTILUS

PREZIOSI NAUTILUS 3 20 x 160 - 126" x 63" LAP. RET.



EXTRA
ORDINARY SIZE

SHADE
SPECTRUM

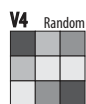
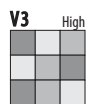
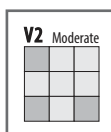

Spessore.
Thickness.
Épaisseur.
Stärke.
Espesor.
Толщина.
厚度。



100% DESIGN
AND PRODUCTION
OF ITALY



PREZIOSI ONICE SMERALDO

LASTRE IN GRES PORCELLANATO PRESSATE A SECCO.

Dry-pressed porcelain stoneware slabs.

Dalles en grès cérame pressées à sec.

Trockengepresste Platten aus Feinsteinzeug.

Planchas en gres porcelánico prensadas en seco.

Керамогранитные плиты сухого прессования.

干压陶瓷砖。

Spessore. **6mm**

Thickness. Épaisseur. Stärke. Espesor. Толщина. 厚度。



320x160cm. 126"x63"
thickness 6mm



160x160cm. 63"x63"
thickness 6mm

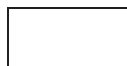

160x80cm. 63"x31 1/2"
thickness 6mm



80x80cm. 31 1/2"x31 1/2"
thickness 6mm



240x120cm. 96"x48"
thickness 6mm



120x120cm. 48"x48"
thickness 6mm



ONICE SMERALDO

PREZIOSI ONICE SMERALDO 320 x 160 - 126" x 63" LAP. RET.



EXTRA
ORDINARY SIZE

SHADE
SPECTRUM

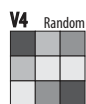
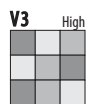
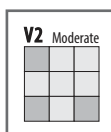

Spessore.
Thickness.
Epaisseur.
Stärke.
Espesor.
Толщина.
厚度.



100% DESIGN
AND PRODUCTION
OF ITALY



PREZIOSI PORTORO

LASTRE IN GRES PORCELLANATO PRESSATE A SECCO

Dry-pressed porcelain stoneware slabs.

Dalles en grès cérame pressées à sec.

Trockengepresste Platten aus Feinsteinzeug.

Planchas en gres porcelánico prensadas en seco.

Керамогранитные плиты сухого прессования.

干压陶瓷砖.

Spessore. **6mm - 10mm**

Thickness. Epaisseur. Stärke. Espesor. Толщина. 厚度.



320x160cm. 126"x63"
thickness 6mm



160x160cm. 63"x63"
thickness 6mm

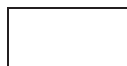

160x80cm. 63"x31 1/2"
thickness 6mm



80x80cm. 31 1/2"x31 1/2"
thickness 6mm



240x120cm. 96"x48"
thickness 6mm



120x120cm. 48"x48"
thickness 6mm



120x60cm. 48"x24"
thickness 10mm

PORTORO

PREZIOSI PORTORO 320 x 160 - 126" x 63" LAP. RET.
VASCA DA BAGNO / BATHTUB PREZIOSI PORTORO LAP. RET.



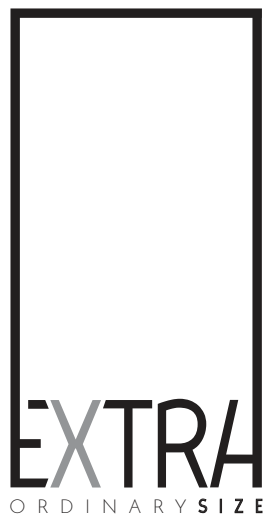

LASTRE IN GRES PORCELLANATO PRESSATE A SECCO.

Dry-pressed porcelain stoneware slabs.
Dalles en grès cérame pressées à sec.
Trockengepresste Platten aus Feinsteinzeug.
Planchas en gres porcelánico prensadas en seco.
Керамогранитные плиты сухого прессования. 干压陶瓷砖。

UNI EN 14411-ISO 13006 appendice C gruppo BIa - UGL

Grande varietà nelle grafiche per un pavimento o rivestimento sempre vario a effetto "naturale". The collection is available in a wide variety of graphics for varied floor or wall solutions with a "natural" effect. Grande varietà des graphiques pour un carrelage de sol ou un revêtement mural toujours différent et un effet "naturel". Große Vielfalt der Graphiken für einen ständig unterschiedlichen Boden- oder Wandbelag mit "natürlichem" Effekt. Gran variedad en las gráficas para un pavimento o revestimiento siempre diferente de efecto "natural". Предлагается большое разнообразие рисунков для укладки всегда меняющегося пола или облицовки с натуральным эффектом. 多样的图案让地板和涂层具有不同的“天然”色彩。

Spessore. Thickness. Epaisseur. Stärke. Espesor. Толщина. 厚度 6mm - 10mm

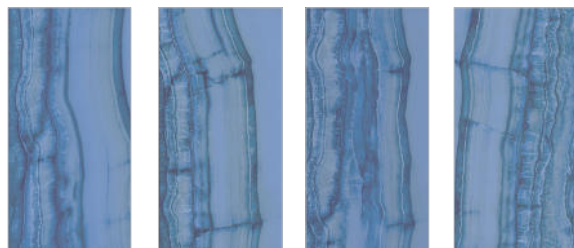

NAUTILUS



ONICE SMERALDO

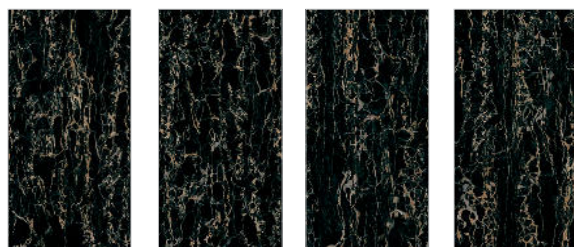

PORTORO

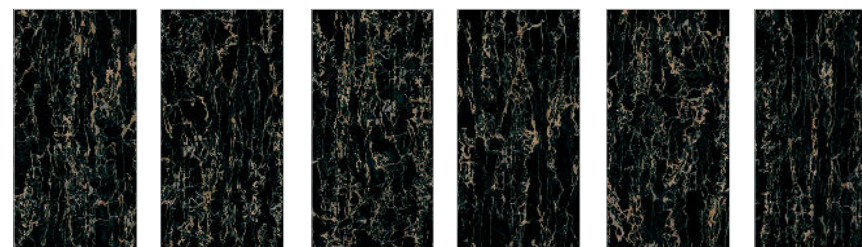
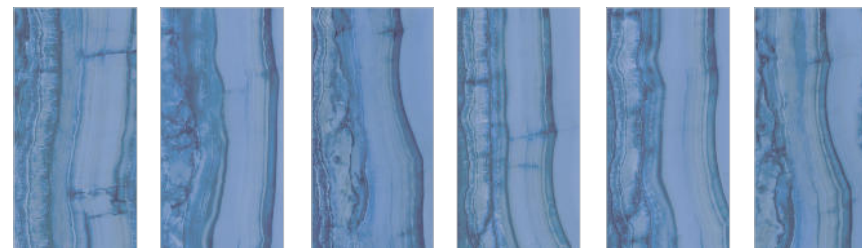

SHADE SPECTRUM

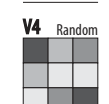
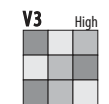
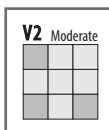
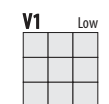

		320x160 126"x63" 6 mm	240x120 96"x48" 6 mm	160x160 63"x63" 6 mm	120x120 48"x48" 6 mm	160x80 63"x31 1/2" 6 mm	240x80 96"x31 1/2" 6 mm	80x80 31 1/2"x31 1/2" 6 mm	120x60 48"x24" 10 mm

Nautilus	o Lap. Ret. 6mm	113001	113010	113020	113030	113040	-	113045	-
Onice Smeraldo	o Lap. Ret. 6mm	113002	113011	113021	113031	113041	-	113046	-
Portoro	o Lap. Ret. 6mm	113003	113012	113022	113032	113042	-	113047	-
	o Lap. Ret. 10mm	-	-	-	-	-	-	-	113052

o Lappato e rettificato.
Lappato and rectified.
Lappato et rectifié.
Lappato und kalibriert.
Lappato y rectificado.

Лапатированный ректифицированный.
亚光和抛光。

DECORI

Decors . Décors . Dekore . Decoraciones . Декоры . 飾

Mosaico

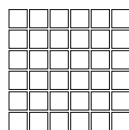

30x30cm. 12"x12" Lap. Ret.
thickness 6mm

* PEZZI SPECIALI

Trims . Pièces spéciales . Formstücke . Piezas especiales . Специальные элементы . 特别部件

COSTA RETTA:

Straight nose:

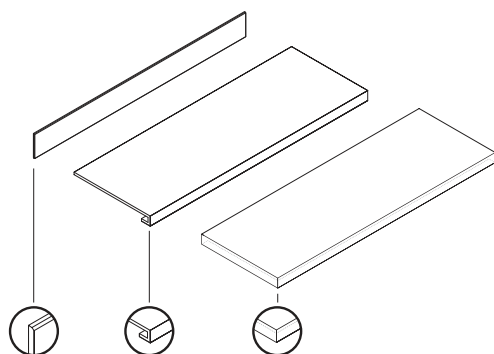

Scuretto
Rabbeted
riser

Gradino
costa retta
Straight
nosed stair

Gradino
costa retta angolo
Straight nosed
corner step

Gradino Costa Retta
160x33x3,2h - 63"x13"x1¹/₄"h

Gradino Costa Retta
120x33x3,2h - 48"x13"x1¹/₄"h

Gradino Costa Retta
80x33x3,2h - 31¹/₂"x13"x1¹/₄"h

Gradino Costa Retta Dx/Sx
160x33x3,2h - 63"x13"x1¹/₄"h

Gradino Costa Retta Dx/Sx
120x33x3,2h - 48"x13"x1¹/₄"h

Gradino Costa Retta Dx/Sx
80x33x3,2h - 31¹/₂"x13"x1¹/₄"h

BORDO DRITTO:

Straight edge:

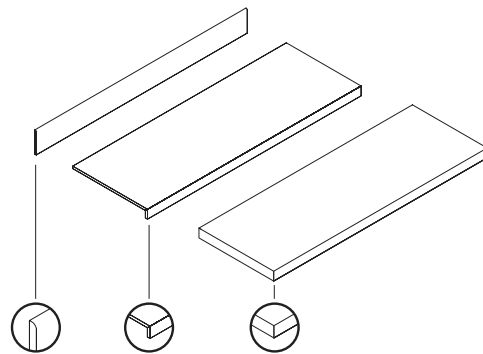

Battiscopa
Skirting

Gradino
bordo dritto
Straight-edge
step

Gradino
bordo dritto angolo
Straight-edge
corner step

Gradino Bordo Dritto
160x30x4h - 63"x12"x1¹/₂"h

Gradino Bordo Dritto
120x30x4h - 48"x12"x1¹/₂"h

Gradino Bordo Dritto
80x30x4h - 31¹/₂"x12"x1¹/₂"h

Gradino Bordo Dritto Dx/Sx
160x30x4h - 63"x12"x1¹/₂"h

Gradino Bordo Dritto Dx/Sx
120x30x4h - 48"x12"x1¹/₂"h

Gradino Bordo Dritto Dx/Sx
80x30x4h - 31¹/₂"x12"x1¹/₂"h

		Battiscopa Skirting 120x6,5 48"x2 ¹ / ₂ "	Battiscopa Skirting 80x8 31 ¹ / ₂ "x3"	Scuretto Rabbeted riser 160x20 63"x8"	Scuretto Rabbeted riser 120x20 48"x8"	Scuretto Rabbeted riser 80x20 31 ¹ / ₂ "x8"
Nautilus	o Lap. Ret. 6 mm	-	✓	✓	-	✓
Onice Smeraldo	o Lap. Ret. 6 mm	-	✓	✓	-	✓
Portoro	o Lap. Ret. 6 mm	-	✓	✓	-	✓
	o Lap. Ret. 10 mm	✓	-	-	✓	-

*

A disposizione solo su richiesta. Tempi di consegna: 30gg.

Available upon request only. Delivery terms: 30 days.
Disponible seulement sur requête. Délais de livraison: 30 jours.
Verfügbar auf Anfrage. Lieferzeit: 30 Tage.
Disponible sólo bajo pedido. Plazo de entrega: 30 días.
Изготавливается только по специальной заявке.
Срок поставки: 30 дней.
仅依订购。交货时间: 30日。

Per il gradino non si garantisce la stessa tonalità del fondo.

We cannot guarantee that the shade of the stair tile will be the same as the background tile.
Pour la marche, nous ne garantissons pas la même tonalité du fond.
Für die Stufe wird nicht der gleiche Farbton des Untergrunds garantiert.
Para el peldaño no se garantiza el mismo tono del fondo.
Для ступени не гарантирована одинаковость тона с фоном.
对于台阶不保证底色一致。

o **Lappato e rettificato.** Lappato and rectified. Lappato et rectifié. Lappato und kalibriert. Lappato y rectificado.
Лаппатированный ректифицированный. 亚光和抛光。

IMBALLI

Package . Emballage . Verpackung . Embalajes . Упаковка . 涂料.

FORMATO cm. Size	SPESSORE. Thickness	TIPOLOGIA IMBALLO. Type of packing	LASTRE Slabs	MQ LASTRA Sqm Slab	KG LASTRA Kg Slab	MQ. Sqm	KG Kg	TARA Tare
320x160	6 mm	Cassa / Crate 345x175x37	14	5,12	74,14	71,68	1.178	140,00
		Cavalletto in legno / Wood A-Frame 330x75x193,5	44			225,28	3.472	210,00
160x160	6 mm	Cassa / Crate 182,6x173,6x40,4	24	2,56	37,07	61,44	962	71,80
		Cavalletto in legno / Wood A-Frame 330x75x193,5	88			225,28	3.472	210,00
240x120	6 mm	Cassa / Crate 264x136x40	20	2,88	41,70	57,60	934	100,00
		Cavalletto in legno / Wood A-Frame 250x75x153,5	44			126,72	1.993	158,00
120x120	6 mm	Cavalletto in legno / Wood A-Frame 250x75x153,5	88	1,44	20,85	126,72	1.993	158,00
160x80	6 mm	Pallet speciale con sponde / Special pallet with sides 168x97x40,9	30	1,28	18,60	38,40	603	45,00

FORMATO cm. Size	SPESSORE. Thickness	TIPOLOGIA IMBALLO. Type of packing	PZ. X SCAT. Pieces x Box	MQ. X SCAT. Sqm x Box	KG X SCAT. Weight x Box	SCAT. X PAL. Boxes x Pal.	MQ. X PAL. Sqm x Pal.	KG X PAL. Weight x Pal.
120x120	6 mm	Pallet speciale con sponde / Special pallet with sides 143x123x64,7	2	2,88	41,70	24	69,12	1.057
80x80	6 mm	Europallet 80x120	3	1,92	27,90	40	76,80	1.141
120x60	10 mm	Europallet 80x120	2	1,44	33,41	30	43,20	1.025

I pesi riportati in tabella sono indicativi in quanto possono subire leggere variazioni per motivi produttivi.

The weights stated in the chart are approximate as some changes may be necessary for production reasons.

Les poids figurant dans le tableau sont fournis à titre indicatif car ils peuvent subir de légères variations pour des raisons de production.

Die in der Tabelle aufgeführten Gewichte sind nicht bindend, da sie aus Produktionsgründen leichte Änderungen aufweisen können.

Los pesos señalados en la tabla son aproximados ya que pueden experimentar ligeras variaciones por motivos productivos.

Указанный в таблице вес является приблизительным, так как ввиду производственных потребностей, он может слегка измениться.

表格记载的重量只具有提示意义，因为可能在生产过程中产生轻微的偏差。

Le condizioni generali di vendita, gli schemi ed i consigli di posa sono consultabili sul sito www.avaceramica.it.

The general conditions of sale, together with the laying diagrams and tips are available on the website www.avaceramica.it.

Les conditions générales de vente, les schémas et les conseils de pose peuvent être consultés sur le site www.avaceramica.it.

Die allgemeinen Verkaufsbedingungen, die Schemen und die Verlegeratschläge befinden sich in der Website www.avaceramica.it.

Las condiciones generales de venta, los esquemas y los consejos para la colocación pueden ser consultados en el sitio www.avaceramica.it.

На сайте www.avaceramica.it вы можете ознакомиться с общими условиями продажи, схемами и рекомендациями по укладке.

CERTIFICAZIONI DI PRODOTTO

Product certification . Certification de produit . Produkt Zertifizierungen . Certificaciones de producto . Сертификация . 产品认证 .

100% DESIGN
AND PRODUCTION
OF ITALY



放射性水平 A 类

Certificazione obbligatoria per l'esportazione in Cina
Certification mandatory for export to China
Certification obligatoire pour l'exportation en Chine
Für den Export nach China obligatorische Zertifizierung
Certificación obligatoria para la exportación a China
Обязательная сертификация для экспорта в Китай

Ceramics of Italy



Azienda Certificata
Certified Company

CARATTERISTICHE TECNICHE

Technical features . Caracteristiques techniques . Technische Eigenschaften . Caracteristicas tecnicas . Технические характеристики . 技术特点 .

LASTRE IN GRES PORCELLANATO PRESSATE A SECCO. Classificazione secondo UNI EN 14411-ISO 13006 - G - Bla (E ≤ 0,5%) UGL

Dry-pressed porcelain stoneware slabs. Product in compliance with UNI EN 14411-ISO 13006 - G - Bla (E ≤ 0,5%) UGL













Dalles en grès cérame pressées à sec. Classement selon UNI EN 14411-ISO 13006 - G - Bla (E ≤ 0,5%) UGL

Trockengepresste Platten aus Feinsteinzeug. Klassifizierung nach UNI EN 14411-ISO 13006 - G - Bla (E ≤ 0,5%) UGL

Planchas en gres porcelánico prensadas en seco. Clasificación según UNI EN 14411-ISO 13006 - G - Bla (E ≤ 0,5%) UGL

Керамогранитные плиты сухого прессования. Классификация согласно европейской сертификации UNI EN 14411-ISO 13006 - G - Bla (E ≤ 0,5%) UGL

干燥压制瓷制砖. 根据UNI EN 14411-ISO 13006 - G - Bla (E ≤ 0,5%) UGL的分类

	CARATTERISTICA Specification Caracteristique Eigenschaft Característica Характеристика 功能	METODO DI PROVA Test methods Methode d'essai Testverfahren Prueba Стандарт испытаний 方法测试	VALORE PRESCRITTO Fixed value Valeur prescrite Vorgeschriebener Wert Valor prescrito Требуемое значение 指引	
	Caratteristiche dimensionali - Dimensional characteristics - Dimensions - Dimensionale Eigenschaften Características dimensionales - Пространственные характеристики - 尺寸特性	ISO 10545-2		Conforme Compliant - Conforme - Erfüllt - Cumple Соответствует - 符合性
	Assorbimento d'acqua - Water absorbtion - Absortion d'eau - Wasseraufnahme Absorción de agua - Водопоглощение - 吸水率	ISO 10545-3	≤ 0,5 %	Conforme Compliant - Conforme - Erfüllt - Cumple Соответствует - 符合性
	Resistenza alla flessione - Breaking modulus - Resistance a la flexion - Biegefestigkeit Resistencia a la flexión - прочность на изгиб - 弯曲强度		≥ 35 N/mm ²	Conforme Compliant - Conforme - Erfüllt - Cumple Соответствует - 符合性
	Sforzo di rottura - Modulus of rupture - Charge de rupture - Bruchlast - Esfuerzo de rotura Стойкость на изгиб - 断裂应力	ISO 10545-4	≥ 7,5 mm = ≥ 1300 N < 7,5 mm = ≥ 700 N	Conforme Compliant - Conforme - Erfüllt - Cumple Соответствует - 符合性
	Resistenza alla abrasione profonda - Deep abrasion resistance - Resistance a l'abrasion profonde Beständigkeit gegen Tiefenverschleiß - Resistencia a la abrasión profunda - Устойчивость к глубокому стиранию по - 深层磨损耐性	ISO 10545-6	≤ 175 mm ³	Conforme Compliant - Conforme - Erfüllt - Cumple Соответствует - 符合性
	Coefficiente di dilatazione termica lineare - Thermal expansion coefficient - Coefficient de dilatation thermique lineaire - Warmausdehnungskoeffizient - Coefficiente de dilatación térmica lineal коэффициент теплового линейного расширения - 线性热膨胀系数	ISO 10545-8		≤ 7x10 ⁻⁶ °C ⁻¹
	Resistenza agli sbalzi termici - Thermal shock resistance - Resistance aux ecarts de temperature Temperaturwechselbeständigkeit - Resistencia a choque térmico Устойчивость к темпепатурным перепадам - 抗热震性	ISO 10545-9		Resistenti Resistant - Résistants - Widerstandsfähig Resiste - устойчивы - 耐性
	Resistenza al gelo - Frost resistance - Resistance au gel - Frostbestaendigkeit - Resistencia al hielo Морозостойкость - 抗冻性	ISO 10545-12		Resistenti Resistant - Résistants - Widerstandsfähig Resiste - устойчивы - 耐性
	Resistenza ai prodotti chimici - Chemical resistance - Resistance aux produits chimiques Chemische Beständigkeit - Resistencia a los productos químicos - Химическая устойчивость - 耐化学腐蚀	ISO 10545-13	min. UB	Resistenti Resistant - Résistants - Widerstandsfähig Resiste - устойчивы - 耐性
	Prodotti chimici ad uso domestico ed additivi per piscina - Household chemicals and swimming pool water cleansers - Produits chimiques courants et additifs pour piscine - Chem.Produkte für den Haushaltsgebrauch und Zusatz für Schwimmbäder - Productos químicos para uso doméstico y con aditivos para piscina - бытовые химические средства и средства для бассейнов - 家用化学产品和游泳池添加剂			
	Acidi ed alcali a bassa concentrazione - Acids and low concentration alkalis - Acides et alcali a faible concentration - Säuren und Alkali in geringer Konzentration - Ácidos y álcalis en baja concentración Низкоконцентрированные кислоты и щёлочи - 低浓度下酸碱度			
	Resistenza alle macchie - Stain resistance - Resistance aux taches - Fleckbeständigkeit Resistencia a las manchas - Устойчивость к загрязнению - 耐油污	ISO 10545-14		Resistenti Resistant - Résistants - Widerstandsfähig Resiste - устойчивы - 耐性
	Stabilità dei colori alla luce - Colour stability to light - Stabilité des couleurs a la lumiere Lichtechtheit der Farben - Estabilidad de los colores - Устойчивость цвета - 光颜色牢度	DIN 51094		Conforme Compliant - Conforme - Erfüllt - Cumple Соответствует - 符合性
	Coefficiente di attrito (scivolosità) Friction coefficient (slipperiness) - Coefficient de frottement (glissance) Reibungskoeffizient (Glätte) - Coeficiente de fricción (deslizabilidad) Коэффициент трения (скользкость) - 摩擦系数 (光滑度)	ANSI A 137.1:2012	≥ 0,42	≥ 0,42 Superficie naturale Natural surface

LA FABBRICA S.p.A. si riserva di apportare, senza alcun preavviso, le modifiche che riterrà più opportune al fine di migliorare il prodotto. Quanto riportato è da considerarsi indicativo e non esaustivo in riferimento ai colori e alle caratteristiche estetiche dei prodotti.

LA FABBRICA S.p.A. reserves the right to make any changes it deems fit in order to improve the product, without prior notice. All images are provided for illustrative purposes only and other colours and aesthetic features are available.

**La Fabbrica S.p.A.**

Via Emilia Ponente, 925
48014 Castel Bolognese (RA) Italy
Tel. +39 0546 - 659911
Fax +39 0546 - 656223
www.avaceramica.it
www.lafabbrica.it

www.avaceramica.itwww.lafabbrica.it

Follow us

