



STONE & CLASSIC
COLLECTION



PIETRA D'ORVIETO



50
Anniversary
| 1973 | 2023

Tagina
ITALY'S BEST SURFACES



PIETRA D'ORVIETO

Gamma della collezione 4

Collection range.
Gamme de la collection.
Sortiment der Kollektion.

Realistic 3D vein effect 5

Ambienti residenziali e Ville 6

Residential environments and Villas.
Environnements résidentiels et Villas.
Wohnumgebungen und Villen.

Ambienti pubblici e commerciali 32

Public and commercial environments.
Environnements publics et commerciaux.
Öffentliche und gewerbliche Räumlichkeiten.

Superfici 44

Surfaces.
Surfaces.
Oberflächen.

INDOOR 48

Decori 48

Decors.
Décors.
Dekore.

OUTDOOR 58

Continuità progettuale indoor-outdoor 58

Design continuity indoors and outdoors.
Continuité conceptuelle à l'intérieur et à l'extérieur.
Entwurfskontinuität im Innen- und Aussenbereich.

Suggerimenti per abbinare colori e stili Tagina 62

Tips for Matching Colours and Tagina Styles.
Conseils pour faire correspondre les couleurs et les styles Tagina.
Tipps für die Kombination von Tagina-Farben und -Stilen.

VIDEO



Clicca qui per vedere il video della collezione.
Click here to watch the video of the collection.
Cliquez ici pour voir la vidéo de la collection.
Klicken Sie hier, um das Video zur Kollektion zu sehen.

PIETRA D'ORVIETO

PIETRA D'ORVIETO si ispira ad una particolare roccia carbonatica estratta in centro Italia, nei pressi della omonima città. Se la ricercata grafica, delicata nei tratti e contraddistinta da leggere striature di colore bruno la rendono icona di eleganza nonché poliedrica nello stile, le 5 finiture superficiali indoor/outdoor la elevano a vera collezione di eccellenza grazie soprattutto alle versioni velvet e naturale dove, sfruttando l'innovativa tecnologia "Realistic 3D vein effect", gli avvallamenti delle vene in superficie coincidono con la texture della grafica sottostante per un effetto estetico e tattile davvero realistico al pari della pietra naturale di cava.

PIETRA D'ORVIETO is inspired by a particular carbonate rock extracted in central Italy, near the city of the same name. Its refined design, characterised by delicate features and marked by light streaks of dark brown, makes it an icon of elegance as well as multifaceted in style. The 5 indoor/outdoor surface finishes elevate it to a true collection of excellence thanks above all to the velvet and natural versions, where, through the innovative 'Realistic 3D vein effect' technology, the grooves of the veins on the surface coincide with the texture of the underlying design for a truly realistic aesthetic and tactile effect on par with natural quarry stone.

PIETRA D'ORVIETO s'inspire d'une roche carbonatée particulière extraite dans le centre de l'Italie, près de la ville du même nom. Si le graphisme raffiné, aux lignes délicates, strié de légers filets bruns en fait une icône d'élégance au style multiforme, les 5 finitions de surface intérieur/extérieur l'élèvent au rang d'excellence grâce surtout aux versions velvet et naturelle où, par la technologie innovante « Realistic 3D vein effect », les dépressions des veines en surface coïncident avec la texture des graphiques sous-jacents pour un effet esthétique et tactile vraiment réaliste digne de la pierre de carrière naturelle.

PIETRA D'ORVIETO ist von einem bestimmten Karbonatgestein inspiriert, das in Mittelitalien in der Nähe der gleichnamigen Stadt abgebaut wird. Das raffinierte grafische Design mit seinen zarten Linien und hellbraunen Schlieren macht ihn zu einer Ikone der Eleganz und des vielseitigen Stils. Die 5 Oberflächenausführungen für den Innen- und Außenbereich machen ihn zu einer echten Spitzenkollektion, vor allem dank den velvet und natürlichen Versionen, bei der die Vertiefungen der Adern auf der Oberfläche dank der innovativen Technologie "Realistic 3D vein effect" mit der Textur des zugrunde liegenden grafischen Designs übereinstimmen und so einen wahrhaft realistischen ästhetischen und taktilen Effekt erzielen, der dem von natürlichem Bruchstein gleichkommt.

100% Made in Italy



BIANCO

Ambienti residenziali e Ville 6
Residential environments and Villas
Environnements résidentiels et Villas
Wohnumgebungen und Villen

BEIGE

Ambienti residenziali e Ville 12
Residential environments and Villas
Environnements résidentiels et Villas
Wohnumgebungen und Villen

Ambienti pubblici e commerciali 32
Public and commercial environments
Environnements publics et commerciaux
Öffentliche und gewerbliche Räumlichkeiten

CENERE

Ambienti residenziali e Ville 18
Residential environments and Villas
Environnements résidentiels et Villas
Wohnumgebungen und Villen

Ambienti pubblici e commerciali 36
Public and commercial environments
Environnements publics et commerciaux
Öffentliche und gewerbliche Räumlichkeiten

SABBIA

Ambienti residenziali e Ville 28
Residential environments and Villas
Environnements résidentiels et Villas
Wohnumgebungen und Villen

Ambienti pubblici e commerciali 38
Public and commercial environments
Environnements publics et commerciaux
Öffentliche und gewerbliche Räumlichkeiten

PIETRA D'ORVIETO



GAMMA DELLA COLLEZIONE

Collection range / Gamme de la collection / Sortiment der Kollektion

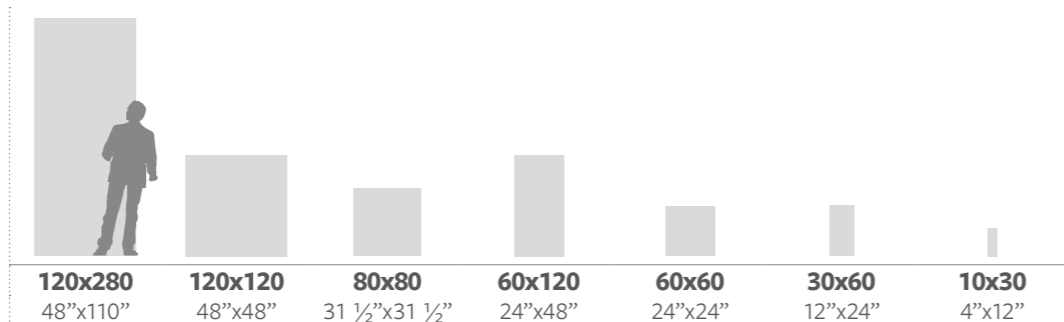

APPLICAZIONI APPLICATIONS ANWENDUNGEN	SPESSORE THICKNESS EPAISSEUR STÄRKE	SUPERFICIE SURFACE SURFACE OBERFLÄCHE	120x280 48"x110"	120x120 48"x48"	80x80 31 1/2"x31 1/2"	60x120 24"x48"	60x60 24"x24"	30x60 12"x24"	10x30 4"x12"
INDOOR	6 mm	□ Nat. Ret.	●						
		○ Bocciaurato Ret.	●						
		◇ Velvet Ret.	●						
	9 mm	□ Nat. Ret.		●	●	●	●	●	●
		○ Bocciaurato Ret.				●	●	●	●
		○ Lucidato Ret.				●	●	●	●
		◇ Velvet Ret.		●	●	●	●	●	●
	OUTDOOR	9 mm	□ Nat. Ret. R11		●		●		
20 mm		□ Nat. Ret. R11		●	●	●			

Realistic 3D vein effect

NATURALEZZA SORPRENDENTE

Grazie all'innovativa tecnologia "Realistic 3D vein effect", che fa coincidere perfettamente le vene alla struttura della piastrella, le finiture **Velvet** e **Naturale** restituiscono una sorprendente sensazione tattile e visiva della superficie ceramica. Un effetto tanto realistico quanto affascinante al tocco e allo sguardo.

SURPRISING NATURALNESS

Thanks to the innovative 'Realistic 3D vein effect' technology, which makes the veins coincide perfectly with the structure of the tile, the **Velvet** and **Natural** finishes give a surprising tactile and visual sensation to the ceramic surface. An effect that is as realistic as it is fascinating to touch and see.

UN NATUREL SURPRENANT

Grâce à la technologie innovante « Realistic 3D vein effect », qui fait coïncider parfaitement les veines avec la structure du carreau, les finitions **Velvet** et **Naturelle** restituent à la surface de la céramique une sensation tactile et visuelle surprenante. Un effet aussi réaliste que fascinant au toucher et à l'œil.

ERSTAUNLICHE NATÜRLICHKEIT

Dank der innovativen Technologie "Realistic 3D-Vein-Effect", die die Adern perfekt an die Struktur der Fliese anpasst, bieten die **Velvet** und **Natürlichen** Finishs ein erstaunliches taktils und visuelles Gefühl der Keramikoberfläche. Ein ebenso realistischer wie faszinierender Effekt für Auge und Haptik.

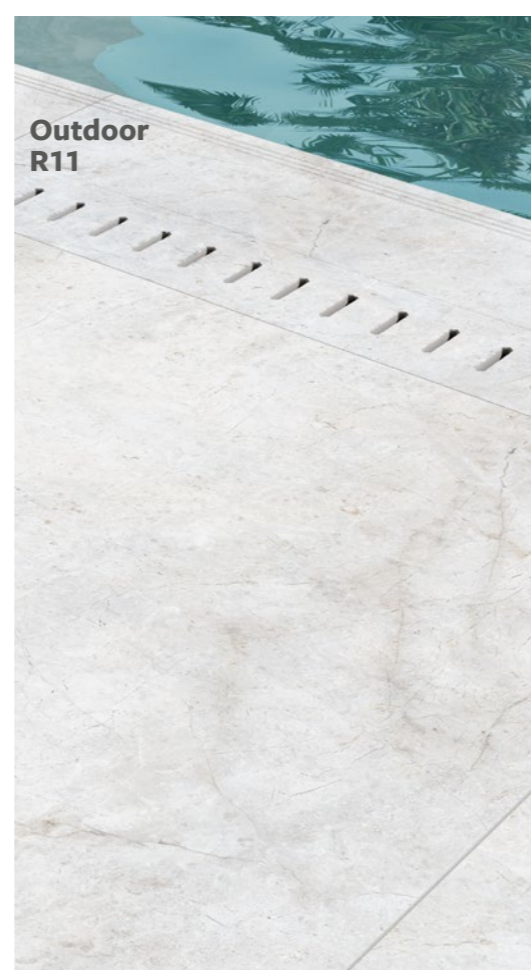
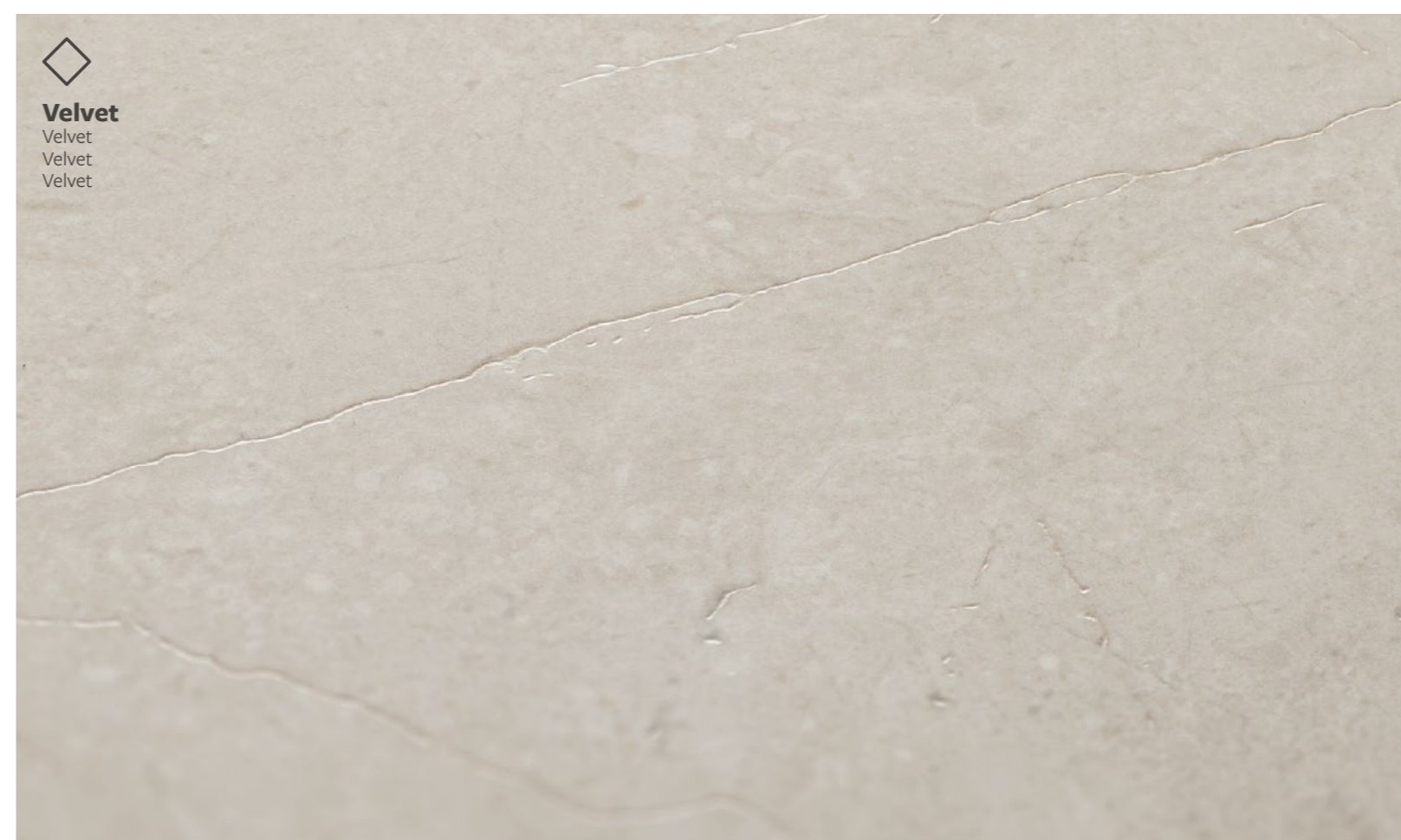
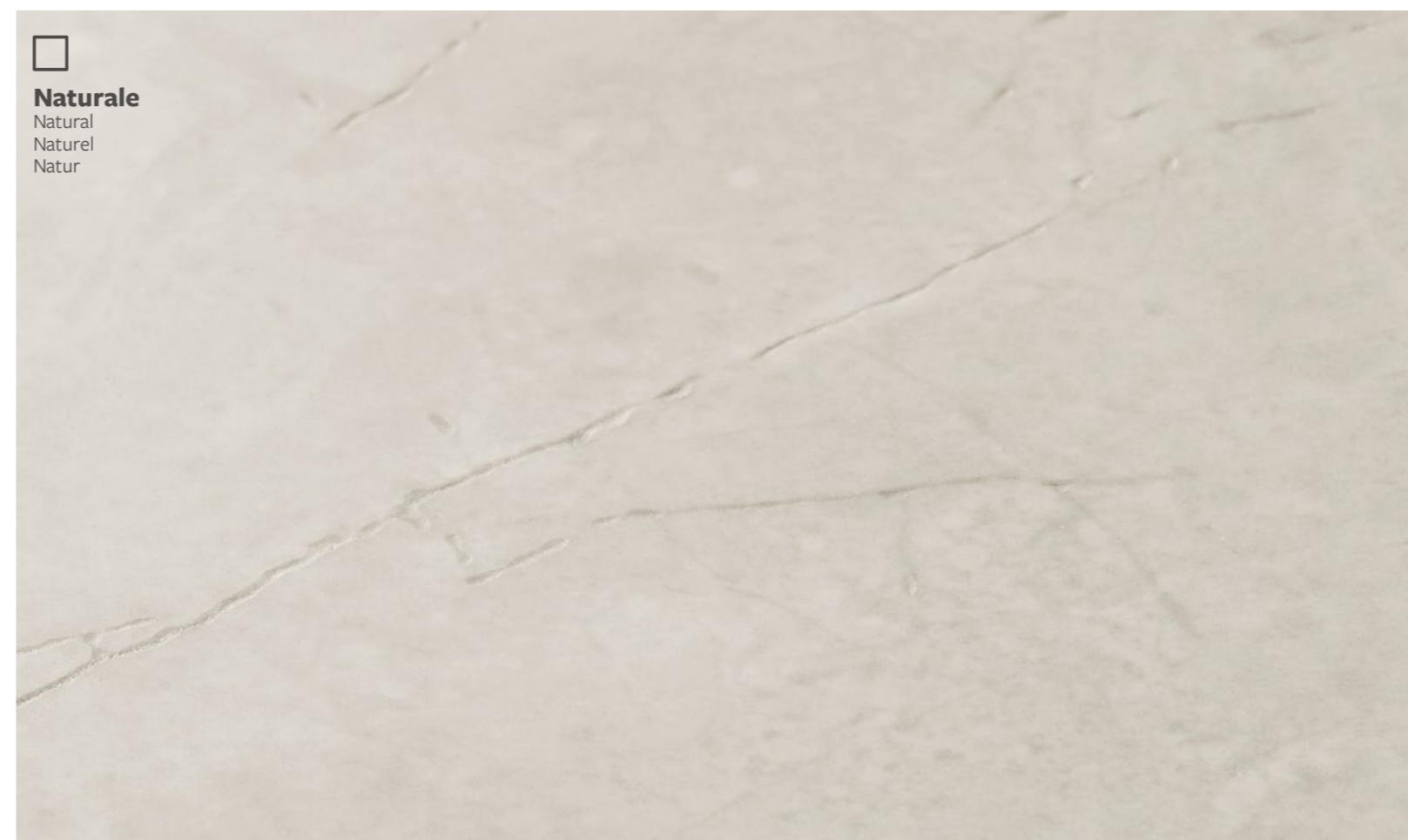

AMBIENTI RESIDENZIALI E VILLE
RESIDENTIAL ENVIRONMENTS AND VILLAS . ENVIRONNEMENTS RÉSIDENTIELS ET VILLAS
WOHNUMGEBUNGEN UND VILLEN

Fedeltà ispirativa e accenti di stile: una nuova sintesi tra naturalità e ricercatezza.

Inspirational fidelity and accents of style: a new synthesis between naturalness and refinement.
Une fidélité inspirante et des accents élégants : une synthèse entre naturel et sophistication.
Inspirierende Treue und stilvolle Akzente: eine neue Synthese aus Natürlichkeit und Raffinesse.

BIANCO

RIVESTIMENTO . WALL
CENERE Decoro Stripes

RIVESTIMENTO CUCINA . KITCHEN BACKSPLASH
CENERE Mosaico Blended 30x30 Ret.

PAVIMENTO . FLOOR
BIANCO 120x120 Nat. Ret.





BIANCO 120x120 20 mm Nat. Ret. R11
BIANCO Elemento a L 33x120x4h 20 mm Nat Ret. R11

Special pieces for swimming pool:
BIANCO Griglia + Ang. 20x60 20 mm Nat. Ret. R11
BIANCO Gradone grip bordo piscina + Ang. 30x120 20 mm Nat. Ret. R11

PARETE . FAÇADE: CENERE 120x280 Nat. Ret.

AMBIENTI RESIDENZIALI E VILLE
RESIDENTIAL ENVIRONMENTS AND VILLAS . ENVIRONNEMENTS RÉSIDENTIELS ET VILLAS
WOHNUMGEBUNGEN UND VILLEN

Una bellezza istintiva e confortevole: massimo valore agli spazi abitativi.

An instinctive and comfortable beauty: maximum value for living spaces.
Une beauté instinctive et confortable : valeur maximale des espaces de vie.
Eine instinktive und komfortable Schönheit: maximaler Wert für Lebensräume.

BEIGE



RIVESTIMENTO . WALL
Collection CALACATTA GOLD 120x280 Lucidato Ret.

PAVIMENTO . FLOOR
BEIGE 60x60 Lucidato Ret.
BEIGE 30x60 Lucidato Ret.



RIVESTIMENTO . WALL
Collection CALACATTA GOLD 120x280 Lucidato Ret.

PAVIMENTO . FLOOR
BEIGE 60x60 Lucidato Ret.
BEIGE 30x60 Lucidato Ret.

AMBIENTI RESIDENZIALI E VILLE

RESIDENTIAL ENVIRONMENTS AND VILLAS . ENVIRONNEMENTS RÉSIDENTIELS ET VILLAS
WOHNUMGEBUNGEN UND VILLEN

Un progetto orientato alla personalizzazione, in linea con le tendenze più attuali.

A project oriented towards customisation, in line with the latest trends.

Un projet orienté vers la personnalisation, en ligne avec les tendances les plus actuelles.

Ein Projekt, das auf die individuelle Gestaltung ausgerichtet ist und den neuesten Trends entspricht.

CENERE



RIVESTIMENTO . WALL
CENERE Decoro Texarts 60x120 Nat. Ret.

PAVIMENTO . FLOOR
CENERE 60x120 Lucidato Ret.

SCALE . STAIRS
CENERE Gradino a C 33x120x3,2 Lucidato Ret.





CENERE 60x120 Bocciardato Ret.



AMBIENTI RESIDENZIALI E VILLE

RESIDENTIAL ENVIRONMENTS AND VILLAS . ENVIRONNEMENTS RÉSIDENTIELS ET VILLAS
WOHNUMGEBUNGEN UND VILLEN

Eleganza, sensibilità decorativa e prestazioni: l'eleganza della pietra a misura di tutti gli ambienti.

Elegance, decorative sensitivity, and performance: the elegance of stone suitable for all environments.

Élégance, sensibilité décorative et performance : l'élégance de la pierre adaptée à tous les environnements.

Eleganz, dekoratives Feingefühl und Leistung: die Eleganz des Steins für jede Räumlichkeit.

SABBIA

RIVESTIMENTO . WALL
SABBIA 60x120 Bocciardato Ret.

PAVIMENTO . FLOOR
SABBIA 60x60 Nat. Ret.



RIVESTIMENTO - WALL
SABBIA Decoro Braid 60x120 Nat. Ret.
SABBIA 60x120 Bocciardato Ret.

PAVIMENTO - FLOOR
SABBIA 60x60 Nat. Ret.



SABBIA Decoro Braid 60x120 Nat. Ret.

AMBIENTI PUBBLICI E COMMERCIALI

PUBLIC AND COMMERCIAL ENVIRONMENTS . ENVIRONNEMENTS PUBLICS ET COMMERCIAUX
ÖFFENTLICHE UND GEWERBLICHE RÄUMLICHKEITEN

Carattere e versatilità: a ogni spazio commerciale l'impronta più congeniale.

Character and versatility: the most congenial style for each commercial space.

Caractère et polyvalence : pour chaque espace commercial, l'empreinte la plus agréable.

Charakter und Vielseitigkeit: der sympathischste Eindruck für jede gewerbliche Räumlichkeit.

BEIGE



RIVESTIMENTO . WALL
BEIGE 60x120 Velvet Ret.
BEIGE 120x280 Bocciardato Ret.

BANCONE . COUNTER
Collection SEGESTA, CARAMEL 6 mm Lucidato

ARREDI . FURNITURE
Collection EVOQUE, DOUSSIE 20x120 Nat. Ret.
DOUSSIE Coprispigolo 1,4x120 Nat. Ret.
DOUSSIE Ang. Coprispigolo 1,4x1,4 Nat. Ret.

PAVIMENTO . FLOOR
BEIGE 60x120 Velvet Ret.
BEIGE Coprispigolo 1,4x120 Velvet Ret.



BANCONE . COUNTER
Collection SEGESTA, CAMEL 6 mm Lucidato

ARREDI . FURNITURE
Collection EVOQUE, DOUSSIE 20x120 Nat. Ret.
DOUSSIE Coprispigo 1,4x120 Nat. Ret.
DOUSSIE Ang. Coprispigo 1,4x1,4 Nat. Ret.

PAVIMENTO . FLOOR
BEIGE 60x120 Velvet Ret.

AMBIENTI PUBBLICI E COMMERCIALI

PUBLIC AND COMMERCIAL ENVIRONMENTS - ENVIRONNEMENTS PUBLICS ET COMMERCIAUX
ÖFFENTLICHE UND GEWERBLICHE RÄUMLICHKEITEN

La naturalezza acquista un volto eclettico: energia di design per le più svariate applicazioni.

Naturalness acquires eclecticism: design energy for the most varied applications.

Le naturel prend un visage éclectique: une énergie de conception pour les applications les plus variées.

Die Natürlichkeit erhält ein eklektisches Gesicht: Design-Energie für die unterschiedlichsten Anwendungen.

CENERE

RIVESTIMENTO . WALL
CENERE 120x280 Nat. Ret.

ARREDI . FURNITURE
Collection STATUARIO 6 mm Nat.

PAVIMENTO . FLOOR
CENERE 80x80 Nat. Ret.



AMBIENTI PUBBLICI E COMMERCIALI

PUBLIC AND COMMERCIAL ENVIRONMENTS . ENVIRONNEMENTS PUBLICS ET COMMERCIAUX
ÖFFENTLICHE UND GEWERBLICHE RÄUMLICHKEITEN

Lo stone look si fa lusso abitativo ed eleva a una nuova dimensione il concetto di accoglienza.

Stone look becomes luxury living and elevates the concept of hospitality to a new dimension.
L'aspect de la pierre devient un luxe vivant et élève le concept d'hospitalité à une nouvelle dimension.
Die Steinoptik wird zu lebendigem Luxus und hebt das Konzept der Gastfreundschaft in eine neue Dimension.

SABBIA

BELVEDERE *****
Hotel & Resort

RIVESTIMENTO . WALL
SABBIA 120x280 Nat. Ret.

BANCONE . COUNTER
BEIGE 6mm Nat.

PAVIMENTO . FLOOR
SABBIA 80x80 Velvet Ret.
SABBIA Decoro Geometric Velvet Ret.



SABBIA 60x120 20 mm



SABBIA 60x120 20 mm Nat. Ret. R11

Special pieces for swimming pool:
SABBIA Gradone grip bordo piscina + Ang. 30x120 20 mm
Nat. Ret. R11 SABBIA Griglia + Ang. 20x60 20 mm Nat. Ret. R11



PIETRA D'ORVIETO

Ogni collezione Tagina rivela la massima cura e una sensibilità artistica raffinata capace di riprodurre la più intima essenza estetica della materia. Colori e trame ricercate si sommano a caratteristiche tecniche di massima qualità grazie alle tecnologie produttive più avanzate. Una superficie Tagina è garanzia di eccellenza e prestigio in ogni genere di spazio legato a emozioni inalterabili nel tempo.

Every Tagina collection shows the utmost attention to detail and a sophisticated artistic sensitivity that reproduces the most intimate aesthetic essence of the material. Refined colours and textures combine with the highest-quality technical characteristics thanks to the most advanced manufacturing technologies. A Tagina surface is a guarantee of excellence and prestige in any kind of environment connected to emotions impervious to time.

Chaque collection Tagina révèle un soin maximal et une sensibilité artistique raffinée capable de reproduire l'essence esthétique la plus intime de la matière. Couleurs et motifs recherchés s'ajoutent à des caractéristiques techniques d'une qualité maximale grâce aux technologies de production les plus avancées. Une surface Tagina est une garantie d'excellence et de prestige dans tous les types d'espace lié à des émotions inaltérables dans le temps.

Jede Tagina-Kollektion zeugt von größter Sorgfalt und einem raffinierten künstlerischen Gespür, das die intimste ästhetische Essenz des Materials wiederzugeben vermag. Raffinierte Farben und Texturen ergänzen sich durch modernste Produktionstechnologien mit hochwertigen technischen Eigenschaften. Eine Oberfläche von Tagina ist eine Garantie für Exzellenz und Wertigkeit in jeder Art von Raum, verbunden mit dauerhaften Emotionen.



SUPERFICI

Surfaces / Surfaces / Oberflächen

BIANCO

Naturale e rettificato.
Natural rectified.
Naturel et rectifié.
Natur Oberfläche und rektifiziert.

Velvet rettificato.
Velvet rectified.
Velvet rectifié.
Velvet rektifiziert.

Lucidato e rettificato.
Glossy rectified.
Brillant et rectifié.
Glossy/Shiny und rektifiziert.

Bocciardato rettificato.
Bush-hammered rectified.
Bouchardé rectifié.
Gehämmert rektifiziert.



BEIGE

Naturale e rettificato.
Natural rectified.
Naturel et rectifié.
Natur Oberfläche und rektifiziert.

Velvet rettificato.
Velvet rectified.
Velvet rectifié.
Velvet rektifiziert.

Lucidato e rettificato.
Glossy rectified.
Brillant et rectifié.
Glossy/Shiny und rektifiziert.

Bocciardato rettificato.
Bush-hammered rectified.
Bouchardé rectifié.
Gehämmert rektifiziert.



SUPERFICI

Surfaces / Surfaces / Oberflächen

CENERE

Naturale e rettificato.
Natural rectified.
Naturel et rectifié.
Natur Oberfläche und rektifiziert.

Velvet rettificato.
Velvet rectified.
Velvet rectifié.
Velvet rektifiziert.

Lucidato e rettificato.
Glossy rectified.
Brillant et rectifié.
Glossy/Shiny und rektifiziert.

Bocciardato rettificato.
Bush-hammered rectified.
Bouchardé rectifié.
Gehämmert rektifiziert.

**SABBIA**

Naturale e rettificato.
Natural rectified.
Naturel et rectifié.
Natur Oberfläche und rektifiziert.

Velvet rettificato.
Velvet rectified.
Velvet rectifié.
Velvet rektifiziert.

Lucidato e rettificato.
Glossy rectified.
Brillant et rectifié.
Glossy/Shiny und rektifiziert.

Bocciardato rettificato.
Bush-hammered rectified.
Bouchardé rectifié.
Gehämmert rektifiziert.



PIETRA D'ORVIETO

Spessore . Thickness . Epaisseur . Stärke - **9 mm**

Gres porcellanato colorato in massa. Full-body coloured porcelain stoneware. Grès cérame coloré dans la masse. In der Masse gefärbtes Feinsteinzeug.

DECORI

Decors / Décors / Dekore

GEOMETRIC



STRIPES



STRIPES: La scatola contiene 4 pezzi per formato, non su rete, nella finitura come illustrato nel dettaglio.

STRIPES: The box contains 4 pieces per size, not on grid (loose), in the finish as shown in the detail sheet.

STRIPES: La boîte contient 4 pièces par format, pas sur filet, dans la finition comme illustré dans le détail.

STRIPES: Die Box enthält 4 Stücke pro Format, nicht auf Netz, in der Ausführung wie im Detail abgebildet.

OPTICAL



OPTICAL: I rombi e i quadrati che compongono il decoro sono forniti nella finitura come illustrato nel dettaglio.

OPTICAL: The rhombuses and squares that make up the decor are supplied in the finish as shown in the detail sheet.

OPTICAL: Les losanges et les carrés qui composent le décor sont fournis dans la finition comme illustré dans le détail.

OPTICAL: Die Rauten und Quadrate, aus denen sich das Dekor zusammensetzt, werden in der Ausführung geliefert, wie im Detail abgebildet.



PAVIMENTO - FLOOR
SABBIA 80x80 Velvet Ret.
SABBIA Decoro Geometric Velvet Ret.

Spessore . Thickness . Epaisseur . Stärke - 9 mm

Gres porcellanato colorato in massa. Full-body coloured porcelain stoneware. Grès cérame coloré dans la masse. In der Masse gefärbtes Feinsteinzeug.

DECORI

Decors / Décors / Dekore

MOSAICO 5x5
30x30 . 12"x12"

BIANCO



Naturale



Velvet



Lucidato



Bocciardato

CENERE



Naturale



Velvet



Lucidato



Bocciardato

BEIGE



Naturale

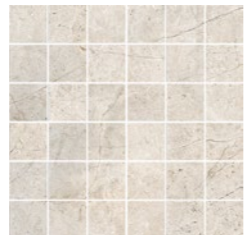

Velvet



Lucidato



Bocciardato

SABBIA



Naturale



Velvet



Lucidato



Bocciardato

I mosaici "Blended" sono composti da un mix di tessere nelle 4 finiture disposte in modo casuale.
The Blended mosaics are composed of a mix of tiles in the 4 finishes arranged randomly.
Les mosaïques Blended sont composées d'un mélange de carreaux dans les 4 finitions disposées au hasard.
Die Blended-Mosaik bestehen aus einem Kachelmix in 4 Ausführungen, die auf zufällige Art und Weise angeordnet sind.

MOSAICO 5x5 BLENDED **30x30 . 12"x12"**

BIANCO



CENERE



BEIGE

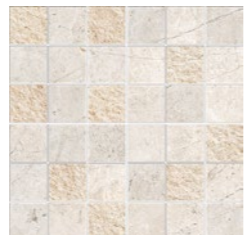

SABBIA



MOSAICO ESAGONA **28x29 . 11"x11 1/2"**

BIANCO



CENERE



BEIGE



SABBIA



BRAID
60x120 . 24"x48"

BIANCO

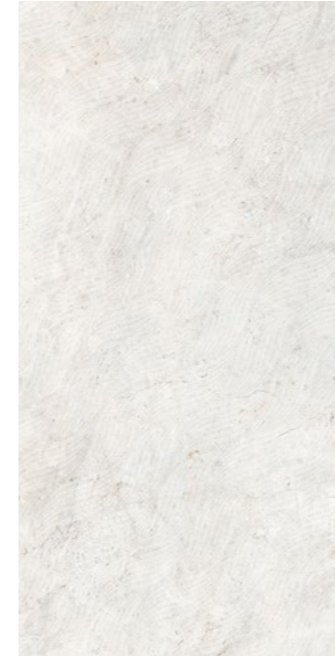

BEIGE

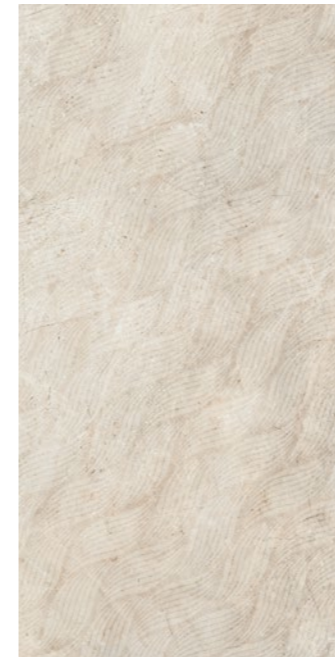

CENERE



SABBIA



TEXARTS
60x120 . 24"x48"

BIANCO

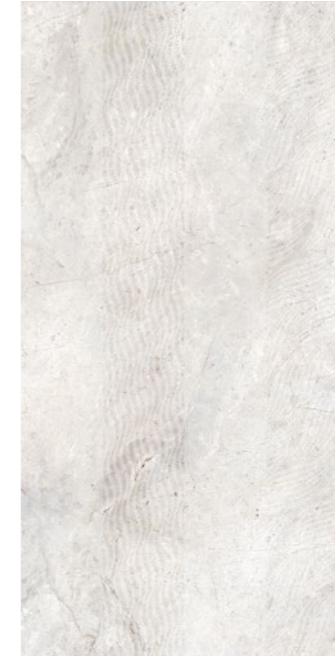

BEIGE



CENERE



SABBIA



PEZZI SPECIALI PER INTERNO 9 mm - □ Nat. Ret.
Special pieces for indoor - Pièces spéciales pour intérieur - Formteile für Innenbereich



Il fascino tradizionale del gradino a "C"

The traditional appeal of the "C" step.
Le charme traditionnel de l'étape « C »
Der traditionelle Charme der „C“-Stufe.

Tagina pone attenzione a tutte le componenti architettoniche degli spazi da abitare. Ai gradini sono dedicati pezzi speciali appositamente progettati per ottenere il massimo risultato estetico. La gamma comprende un elemento "gradino a C" al quale si possono affiancare gli elementi che completano gli angoli sinistro e destro.

Tagina takes great care over all the architectural elements of the living spaces. Special pieces are used for the stairs, specially designed to obtain the maximum aesthetic result. The range includes a "C-step" element which can be combined with the elements that complete the left and right corners.

Tagina prête attention à toutes les composantes architecturales des espaces de vie. Les étapes sont dédiées à des pièces spéciales spécialement conçues pour obtenir un résultat esthétique maximal. La gamme comprend un élément « marche en C » auquel vous pouvez assortir les autres éléments qui complètent les angles gauche et droit.

Tagina achtet auf alle architektonischen Komponenten der Wohnräume. Den Stufen sind Spezialteile gewidmet, um ein optimales ästhetisches Ergebnis zu erzielen. Das Sortiment umfasst ein „C-Stufen-Element“, das durch Elemente zur Vervollständigung der linken und rechten Ecke ergänzt werden kann.

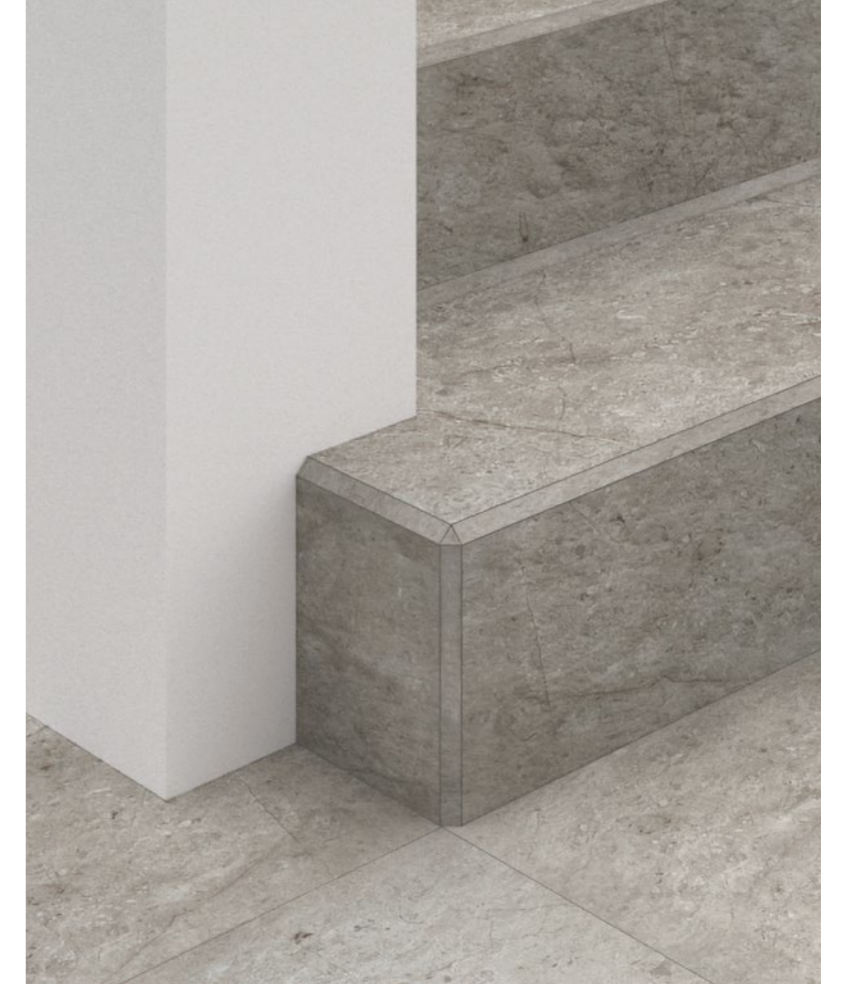
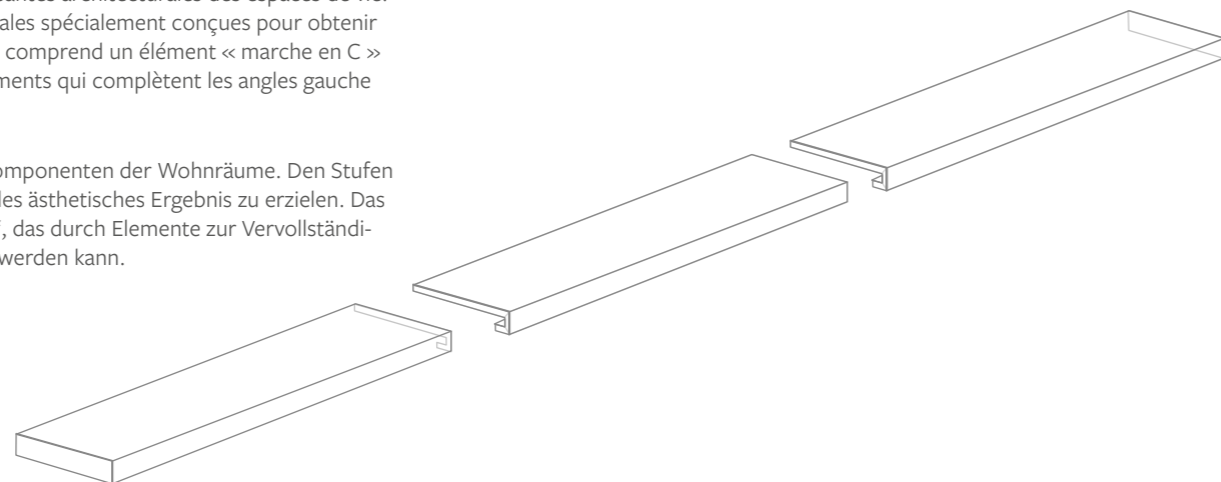

Il "coprispigolo triangolare"

The "triangular edge cover".
Le « cache-arête triangulaire »
„Dreieckiger Kantenschutz“

La gamma della collezione include l'elemento "Coprispigolo triangolare" e "Angolo Coprispigolo triangolare". Consentono di risolvere con eleganza e semplicità problematiche legate alla congiunzione delle lastre in presenza di spigoli e angoli. È possibile adottare questa soluzione sia a rivestimento che a pavimento ad esempio per realizzare gradini o per comporre volumi geometrici.

The range of the collection includes the "Triangular edge cover and triangular corner edge cover" element. They allow problems encountered to be solved elegantly and simply when joining slabs where there are edges and corners. It is possible to adopt this solution both for cladding and flooring, e.g. to create steps or compose geometric volumes.

La gamme de la collection comprend l'élément « Cache-arête triangulaire et Angle Cache-arête Triangulaire ». Ils permettent de résoudre avec élégance et simplicité les problèmes liés à l'assemblage des dalles en présence de bords et de coins. Il est possible d'adopter cette solution aussi bien pour le revêtement que pour le dallage, par exemple pour créer des marches ou composer des volumes géométriques.

Das Sortiment der Kollektion umfasst das Element „Dreieckiger Kantenschutz und Dreieckige Eckabdeckung“. Beide Elemente ermöglichen, mit Eleganz und Einfachheit alle Probleme zu lösen, die mit dem Zusammenfügen der Platten bei Vorhandensein von Kanten und Ecken zusammenhängen. Diese Lösung kann sowohl für Verkleidungen als auch für Böden verwendet werden, beispielsweise um Stufen oder geometrische Volumen zu schaffen.



PIETRA D'ORVIETO

Spessore . Thickness . Epaisseur . Stärke - 6 mm

Lastre in gres porcellanato pressate a secco . Dry-pressed porcelain stoneware slabs . Dalles en grès cérame pressées à sec . Trocken gepresste Platten aus Feinsteinzeug.

Spessore . Thickness . Epaisseur . Stärke - 9 mm

Gres porcellanato colorato in massa . Full-body coloured porcelain stoneware . Grès cérame coloré dans la masse . In der Masse gefärbtes Feinsteinzeug.

INDOOR

TABELLA RIEPILOGATIVA
Summary table
Tableau récapitulatif
Zusammenfassende Tabelle

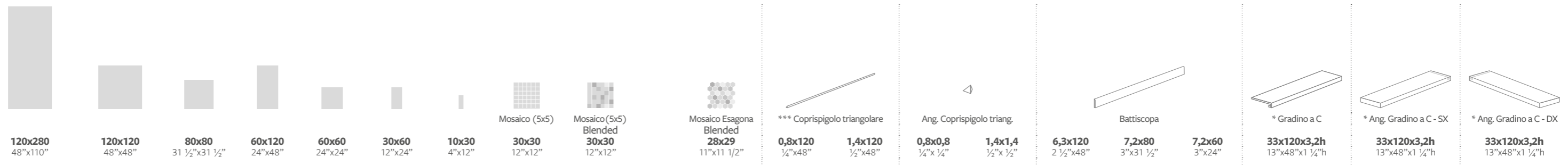

SPESSORE - THICKNESS - EPAISSEUR - STÄRKE		6 mm	9 mm	9 mm	9 mm	9 mm	9 mm	9 mm	9 mm	9 mm	9 mm	9 mm	6 mm	9 mm	6 mm	9 mm	9 mm	9 mm	9 mm	9 mm	9 mm		
	□ Nat. Ret.	138001	138021	138017	138041	138069	138071	138091	138300				138324	138400	138420	138440	138460	138150	138166	138170	138200	138264	138232
	○ Bocciardato Ret.	138002	-	-	138042	138070	138072	138092	138301				138324	138401	138421	138441	138461	138151	-	138171	138201	138265	138233
	○ Lucidato Ret.	-	-	-	138043	138129	138073	138093	138302				138324	-	138422	-	138462	138152	-	138172	138202	138266	138234
	◇ Velvet Ret.	138004	138024	138020	138044	138107	138074	138094	138303				138324	138403	138423	138443	138463	138153	138169	138173	138203	138267	138235
	□ Nat. Ret.	138005	138025	138037	138045	138108	138075	138095	138304				138325	138404	138424	138444	138464	138154	138186	138174	138204	138268	138236
	○ Bocciardato Ret.	138006	-	-	138046	138109	138076	138096	138305				138325	138405	138425	138445	138465	138155	-	138175	138205	138269	138237
	○ Lucidato Ret.	-	-	-	138047	138130	138077	138097	138306				138325	-	138426	-	138466	138156	-	138176	138206	138270	138238
	◇ Velvet Ret.	138008	138028	138040	138048	138110	138078	138098	138307				138325	138407	138427	138447	138467	138157	138189	138177	138207	138271	138239
	□ Nat. Ret.	138009	138029	138057	138049	138119	138079	138099	138308				138326	138408	138428	138448	138468	138158	138190	138178	138208	138272	138240
	○ Bocciardato Ret.	138010	-	-	138050	138120	138080	138100	138309				138326	138409	138429	138449	138469	138159	-	138179	138209	138273	138241
	○ Lucidato Ret.	-	-	-	138051	138131	138081	138101	138310				138326	-	138430	-	138470	138160	-	138180	138210	138274	138242
	◇ Velvet Ret.	138012	138032	138060	138052	138121	138082	138102	138311				138326	138411	138431	138451	138471	138161	138193	138181	138211	138275	138243
	□ Nat. Ret.	138013	138033	138087	138053	138122	138083	138103	138312				136327	138412	138432	138452	138472	138162	138194	138182	138212	138276	138244
	○ Bocciardato Ret.	138014	-	-	138054	138123	138084	138104	138313				136327	138413	138433	138453	138473	138163	-	138183	138213	138277	138245
	○ Lucidato Ret.	-	-	-	138055	138132	138085	138105	138314				136327	-	138434	-	138474	138164	-	138184	138214	138278	138246
	◇ Velvet Ret.	138016	138036	138090	138056	138124	138086	138106	138315				136327	138415	138435	138455	138475	138165	138197	138185	138215	138279	138247
MQ x pezzo - Sqm x pcs	3,36																						
Kg x pezzo - Kg x pcs	48,6																						
N° □ m²		20																					
		67,2																					
** Kg	1062																						
m² x Kg x		2,88	2	2	1,44	1,08	0,6	0,99	0,99														
		58	26	26	29	22	12	19,5	19,5														
m² x * Kg x		18	40	40	30	40	40	72															
		51,84	51,2	43,2	43,2	43,2	43,2	884															
h x		1097	1060	890	900	900	884																
		65	95	75	75	75	73																
Imballo (tara) - Packaging (tare)	(90)	(53)	(20)	(20)	(20)	(20)	(20)	(20)	(20)				(20)	(20)	(20)	(20)	(20)	(20)	(20)	(20)	(20)	(20)	(20)
N° □ m²		44																					
		147,84																					
** Kg	2259																						
Imballo (tara) - Packaging (tare)	(120)																						

I pesi riportati in tabella sono indicativi e potrebbero essere soggetti a leggere variazioni.
The weights stated in the chart may undergo slight changes for production reasons.
Les poids indiqués dans le tableau peuvent subir de légères variations pour des raisons de production.
Die in der Tabelle angegebenen Gewichte können aus Produktionsgründen geringfügigen Abweichungen unterliegen.

Non si garantisce l'abbinabilità tra fondi di spessori diversi e tra fondo e pezzo speciale.
It is not guaranteed that background tiles with different thicknesses can be used together, nor is it guaranteed for background tiles and trims.
Nous ne garantissons pas la possibilité de combiner des carrelages de sol de différentes épaisseurs et un carrelage de sol avec une pièce spéciale.
Die Kombinierbarkeit von Fliesen unterschiedlicher Stärke sowie zwischen Fliese und Formteil kann nicht garantiert werden.

I mosaici "Blended" sono composti da un mix di tessere nelle 4 finiture disposte in modo casuale.
The Blended mosaics are composed of a mix of tiles in the 4 finishes arranged randomly.
Les mosaïques Blended sont composées d'un mélange de carreaux dans les 4 finitions disposées au hasard.
Die Blended-Mosaik bestehen aus einem Kachelmix in 4 Ausführungen, die auf zufällige Art und Weise angeordnet sind.

* A disposizione solo su richiesta. Tempi di consegna 30 gg.
Available upon request only. Delivery terms: 30 days.
Disponible seulement sur requête. Délais de livraison: 30 jours.
Verfügbar auf Anfrage. Lieferzeit: 30 Tage.

** Il peso è comprensivo dell'imballo.
The total weight includes the packaging.
Le poids comprend aussi l'emballage.
Das Gesamtgewicht enthält auch die Verpackung.

*** Vendita a scatola completa.
Full box sale.
Vente à la boîte complète.
Volle Kartons.

- Naturale e rettificato. Natural rectified. Naturel et rectifié. Natur Oberfläche und rektifiziert.
- Bocciardato rettificato. Bush-hammered rectified. Boucharde rectifié. Gehämmert und rektifiziert.
- Lucidato e rettificato. Glossy rectified. Brillant et rectifié. Glossy/Shiny und rektifiziert.
- ◇ Velvet rettificato. Velvet rectified. Velvet rectifié. Velvet rektifiziert.

PIETRA D'ORVIETO

Spessore . Thickness . Epaisseur . Stärke - **9 mm**

Gres porcellanato colorato in massa. Full-body coloured porcelain stoneware. Grès cérame coloré dans la masse. In der Masse gefärbtes Feinsteinzeug.

DECORI

Decors / Décors / Dekore

TABELLA RIEPILOGATIVA

Summary table

Tableau récapitulatif

Zusammenfassende Tabelle



* Braid
60x120
24"x48"



* Texarts
60x120
24"x48"



* Geometric



* Stripes



* Optical

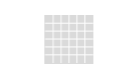

Mosaico (5x5)
30x30
12"x12"



Mosaico (5x5)
Blended
30x30
12"x12"



Mosaico Esagona
Blended
28x29
11"x11 1/2"

SPESSORE - THICKNESS - EPAISSEUR - STÄRKE		9 mm	9 mm	9 mm	9 mm	9 mm	9 mm	9 mm	9 mm
	<input type="checkbox"/> Nat. Ret.	138358	138362	138334				138300	
	<input type="checkbox"/> Bocciardato Ret.	-	-	138335	138330	138354		138301	138320
	<input type="checkbox"/> Lucidato Ret.	-	-	138336				138302	
	<input type="checkbox"/> Velvet Ret.	-	-	138337				138303	138324
	<input type="checkbox"/> Nat. Ret.	138359	138363	138338				138304	
	<input type="checkbox"/> Bocciardato Ret.	-	-	138339	138331	138355		138305	138321
	<input type="checkbox"/> Lucidato Ret.	-	-	138340				138306	
	<input type="checkbox"/> Velvet Ret.	-	-	138341				138307	138325
	<input type="checkbox"/> Nat. Ret.	138360	138364	138342				138308	
	<input type="checkbox"/> Bocciardato Ret.	-	-	138343	138332	138356		138309	138322
	<input type="checkbox"/> Lucidato Ret.	-	-	138344				138310	
	<input type="checkbox"/> Velvet Ret.	-	-	138345				138311	138326
	<input type="checkbox"/> Nat. Ret.	138361	138365	138350				138312	
	<input type="checkbox"/> Bocciardato Ret.	-	-	138351	138333	138357		138313	138323
	<input type="checkbox"/> Lucidato Ret.	-	-	138352				138314	
	<input type="checkbox"/> Velvet Ret.	-	-	138353				138315	138327
N° m²									
** Kg									
m² x		1	1		16		11	11	11
Kg x		0,72	0,72		0,96		0,99	0,99	0,89
m² x		15,5	15,5		21,5		19,5	19,5	17,5
** Kg x									
h x									
Imballo (tara) - Packaging (tare)									

I decori si abbinano al fondo ma possono essere di tonalità diversa.
Decors match the base but may be of a different tone.
Les décors sont assortis au fond, mais les tonalités peuvent être différentes.
Die Dekore passen zum Unifliese, können jedoch unterschiedliche Farbtöne aufweisen.

* A disposizione solo su richiesta. Tempi di consegna 30 gg.
Available upon request only. Delivery terms: 30 days.
Disponible seulement sur requête. Délais de livraison: 30 jours.
Verfügbar auf Anfrage. Lieferzeit: 30 Tage.

- Naturale e rettificato. Natural rectified. Naturel et rectifié. Natur Oberfläche und rektifiziert.
- Bocciardato rettificato. Bush-hammered rectified. Bouchardé rectifié. Gehämmert und rektifiziert.
- Lucidato e rettificato. Glossy rectified. Brillant et rectifié. Glossy/Shiny und rektifiziert.
- Velvet rettificato. Velvet rectified. Velvet rectifié. Velvet rektifiziert.

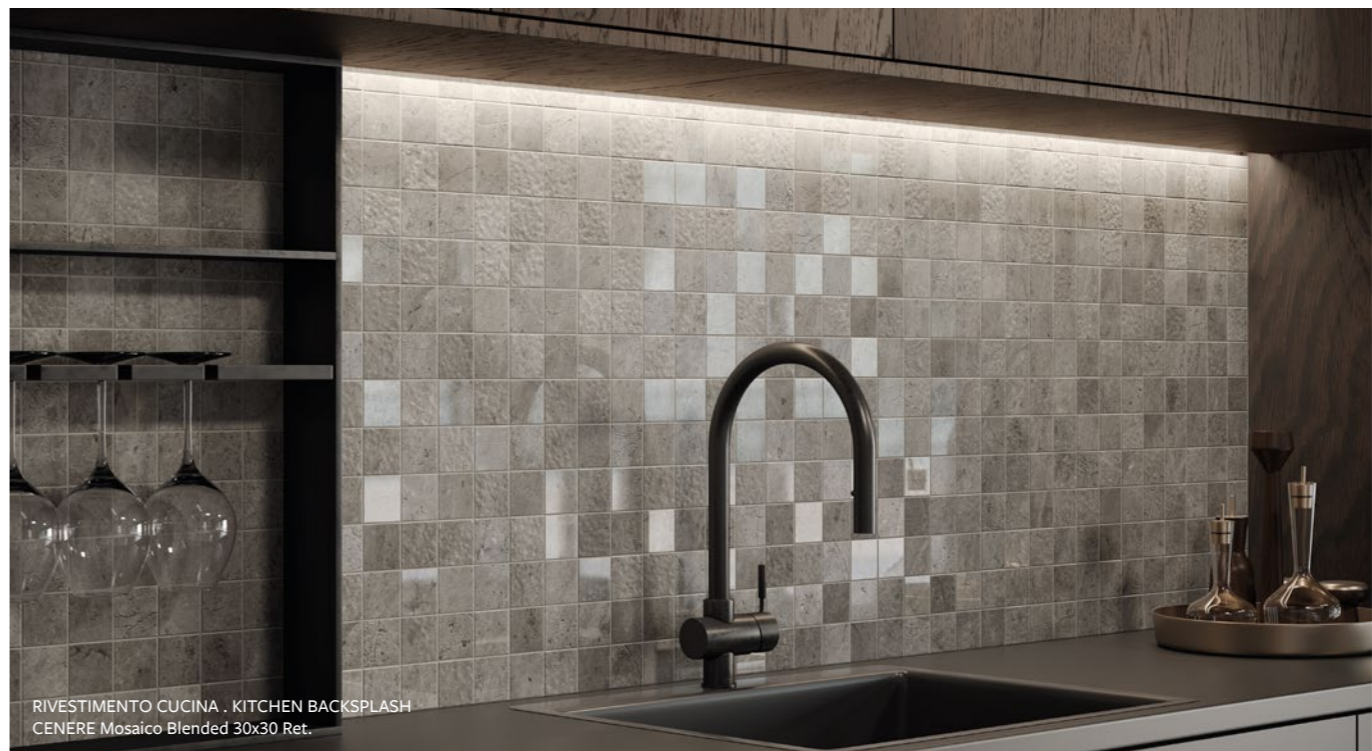

RIVESTIMENTO CUCINA . KITCHEN BACKSPLASH
CENERE Mosaico Blended 30x30 Ret.



RIVESTIMENTO CUCINA . KITCHEN BACKSPLASH
CENERE Mosaico Esagona Blended 28x29

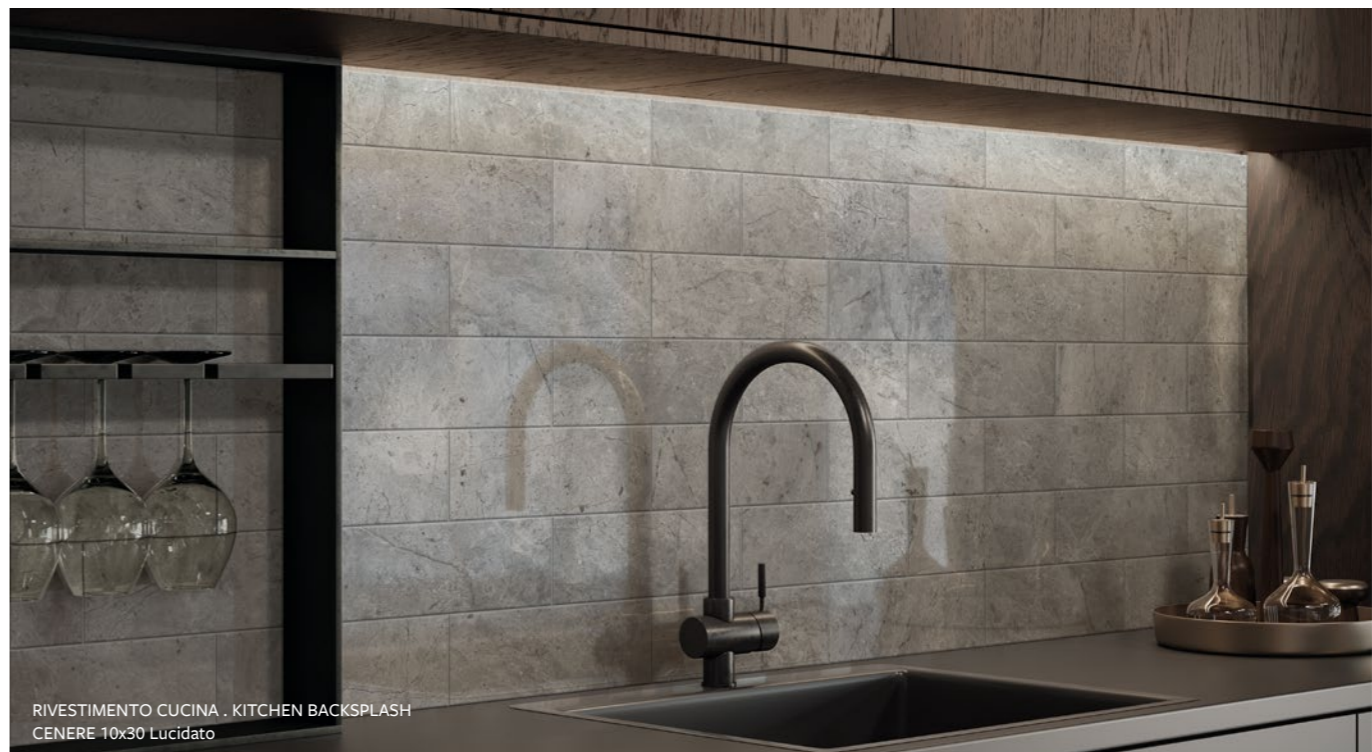

RIVESTIMENTO CUCINA . KITCHEN BACKSPLASH
CENERE 10x30 Lucidato

CONTINUITÀ PROGETTUALE INDOOR-OUTDOOR

Design continuity indoors and out / Continuité conceptuelle à l'intérieur et à l'extérieur / Entwurfskontinuität im Innen- und Aussenbereich

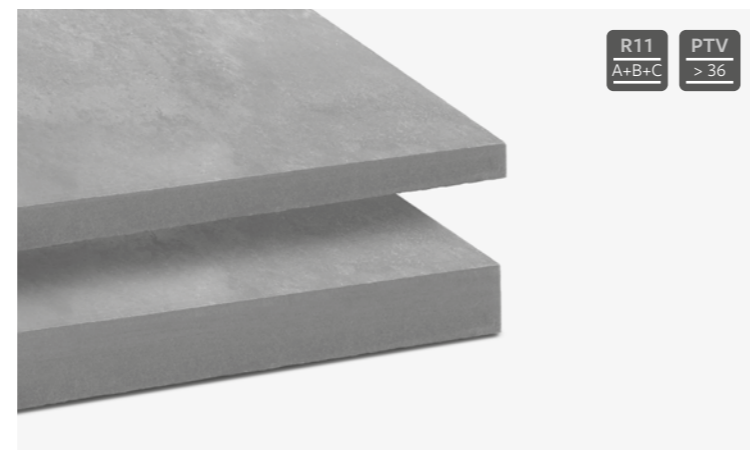

INDOOR

Soluzioni contemporanee per l'interior design
Contemporary solutions for interior design.
Solutions contemporaines pour le design intérieur.
Zeitgemäße Lösungen für das Interior Design.

OUTDOOR

Versatilità e prestazioni per la progettazione in esterna
Versatility and performance for outdoor design.
Polyvalence et performance pour l'aménagement extérieur.
Vielseitigkeit und Leistungen für Outdoor-Design.

SISTEMI DI POSA

Laying systems / Systemes de pose / Verlegearten

Posa su erba

Laying on grass
Pose sur l'herbe
Verlegung auf Wiese

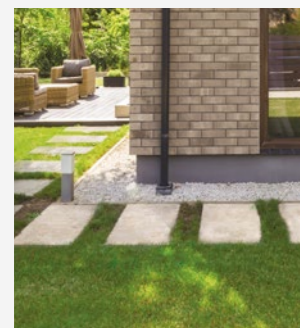

Posa su sabbia

Laying on sand
Pose sur sable
Verlegung auf Sand

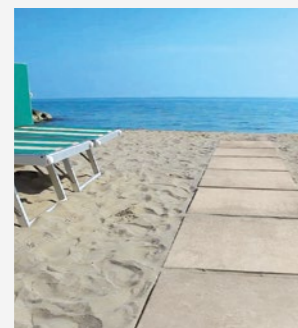

Posa sopraelevata

Raised laying
Pose surélevée
Verlegung auf Stelzlagern

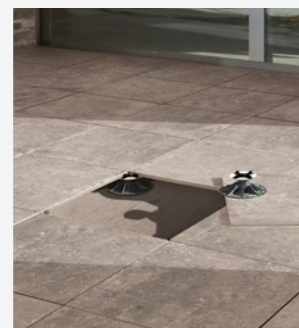

Posa su ghiaia

Laying on gravel
Pose sur gravier
Verlegung auf Kies

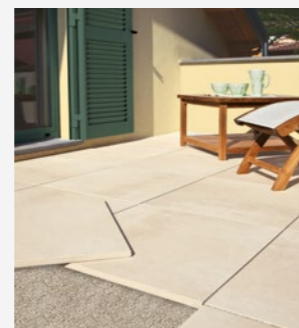

Posa tradizionale

Standard laying
Pose traditionnelle
Herkömmliche Verlegung

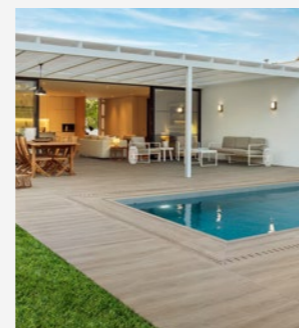

Spessore . Thickness . Epaisseur . Stärke - 9 mm R11 - 20 mm R11

Gres porcellanato colorato in massa. Full-body coloured porcelain stoneware. Grès cérame coloré dans la masse. In der Masse gefärbtes Feinsteinzeug.

OUTDOOR

TABELLA RIEPILOGATIVA
Summary table
Tableau récapitulatif
Zusammenfassende Tabelle

		120x120 48"x48"	60x120 24"x48"	120x120 48"x48"	80x80 31 1/2"x31 1/2"	60x120 24"x48"	15x30x4h 6"x12"x1 1/2"h
SPESSORE - THICKNESS - EPAISSEUR - STÄRKE		9 mm	9 mm	20 mm	20 mm	20 mm	9,5 mm
	<input type="checkbox"/> Nat. Ret.	138125	138061	138115	138111	138065	
	<input checked="" type="checkbox"/> Nat. Nat.						138501
	<input type="checkbox"/> Nat. Ret.	138126	138062	138116	138112	138066	
	<input checked="" type="checkbox"/> Nat. Nat.						138502
	<input type="checkbox"/> Nat. Ret.	138127	138063	138117	138113	138067	
	<input checked="" type="checkbox"/> Nat. Nat.						138503
	<input type="checkbox"/> Nat. Ret.	138128	138064	138118	138114	138068	
	<input checked="" type="checkbox"/> Nat. Nat.						138504
		Pallet speciale Special pallet 123x144	Pallet 80x120	Pallet speciale Special pallet 123x144	Pallet 80x120	Pallet 80x120	Pallet 80x120
N°							
m²							
** Kg							
		2	2	1	1	1	6
m² x		2,88	1,44	1,44	0,64	0,72	7,5
Kg x		58	29	64	28,5	32	
		18	30	18	45	30	
m² x		51,84	43,2	25,92	28,8	21,6	
** Kg x		1097	890	1205	1302,5	980	
h x		65	75	65	100	75	
Imballo (tara) - Packaging (tare)		(53)	(20)	(53)	(20)	(20)	(20)

I pesi riportati in tabella sono indicativi e potrebbero essere soggetti a leggere variazioni.
The weights stated in the chart may undergo slight changes for production reasons.
Les poids indiqués dans le tableau peuvent subir de légères variations pour des raisons de production.
Die in der Tabelle angegebenen Gewichte können aus Produktionsgründen geringfügigen Abweichungen unterliegen.

Non si garantisce l'abbinabilità tra fondi di spessori diversi e tra fondo e pezzo speciale.
It is not guaranteed that background tiles with different thicknesses can be used together, nor is it guaranteed for background tiles and trims.
Nous ne garantissons pas la possibilité de combiner des carrelages de sol de différentes épaisseurs et un carrelage de sol avec une pièce spéciale.
Die Kombinierbarkeit von Fliesen unterschiedlicher Stärke sowie zwischen Fliese und Formteil kann nicht garantiert werden.

** Il peso è comprensivo dell'imballo.
The total weight includes the packaging.
Le poids comprend aussi l'emballage.
Das Gesamtgewicht enthält auch die Verpackung.

Naturale e rettificato.
Natural rectified.
Naturel et rectifié.
Natur Oberfläche und rektifiziert.

Naturale e naturale.
Natural and natural.
Naturel et naturel.
Natur natur.

* A disposizione solo su richiesta. Tempi di consegna 30 gg.
Available upon request only. Delivery terms: 30 days.
Disponible seulement sur requête. Délais de livraison: 30 jours.
Verfügbar auf Anfrage. Lieferzeit: 30 Tage.

Monolitico
Monolithic step
Monolitico
Monolithische Stufenplatte

PIETRA D'ORVIETO

PEZZI SPECIALI PER ESTERNO 20 mm R11 - □ Nat. Ret.
Special pieces for outdoor - Pièces spéciales pour extérieur - Formteile für Aussenbereich

Elemento a L



Gradone grip

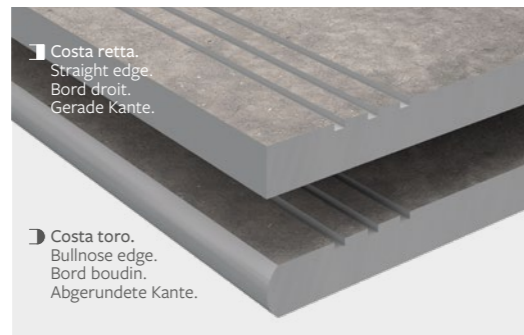

Gradone

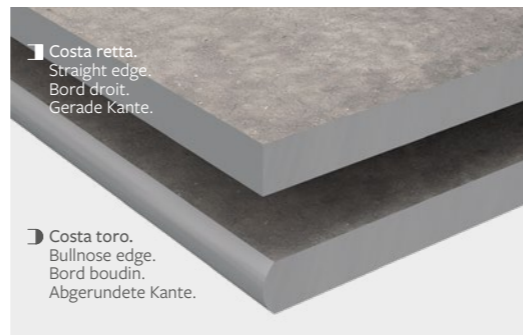

Gradone svasato bordo piscina

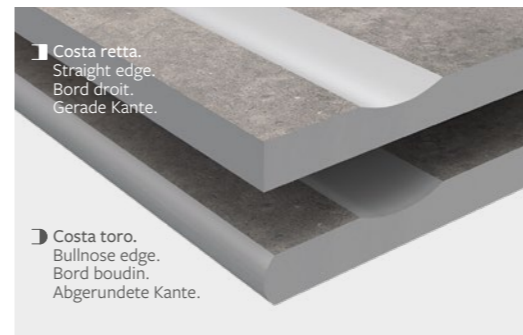

Gradone grip bordo piscina

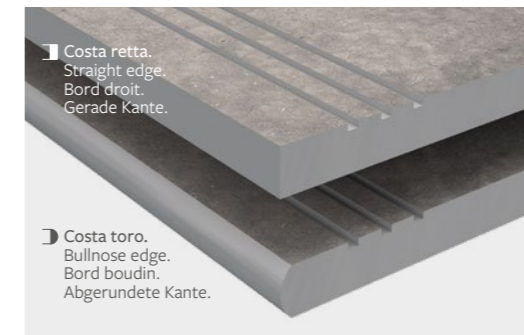

Gradone bordo piscina

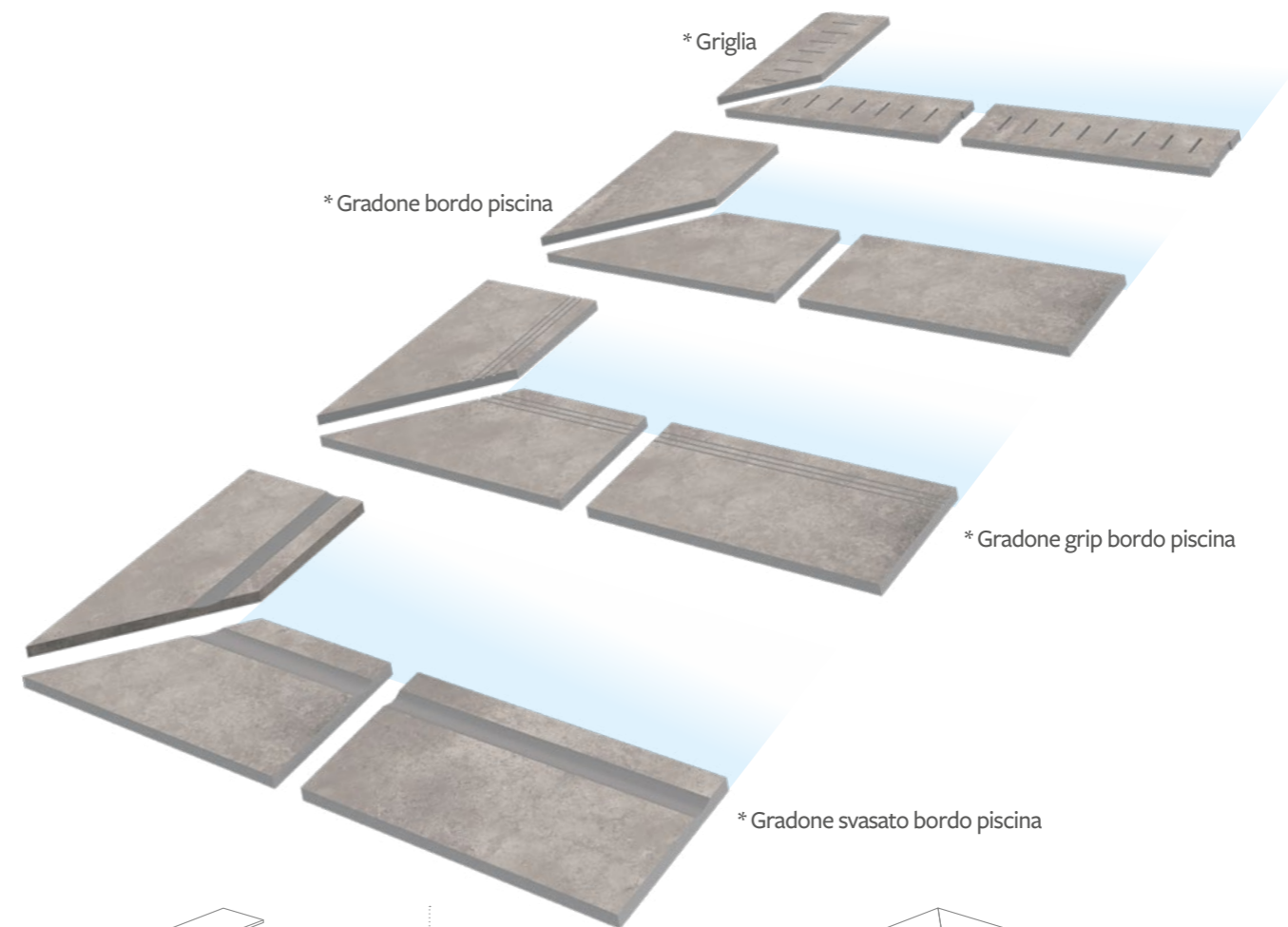
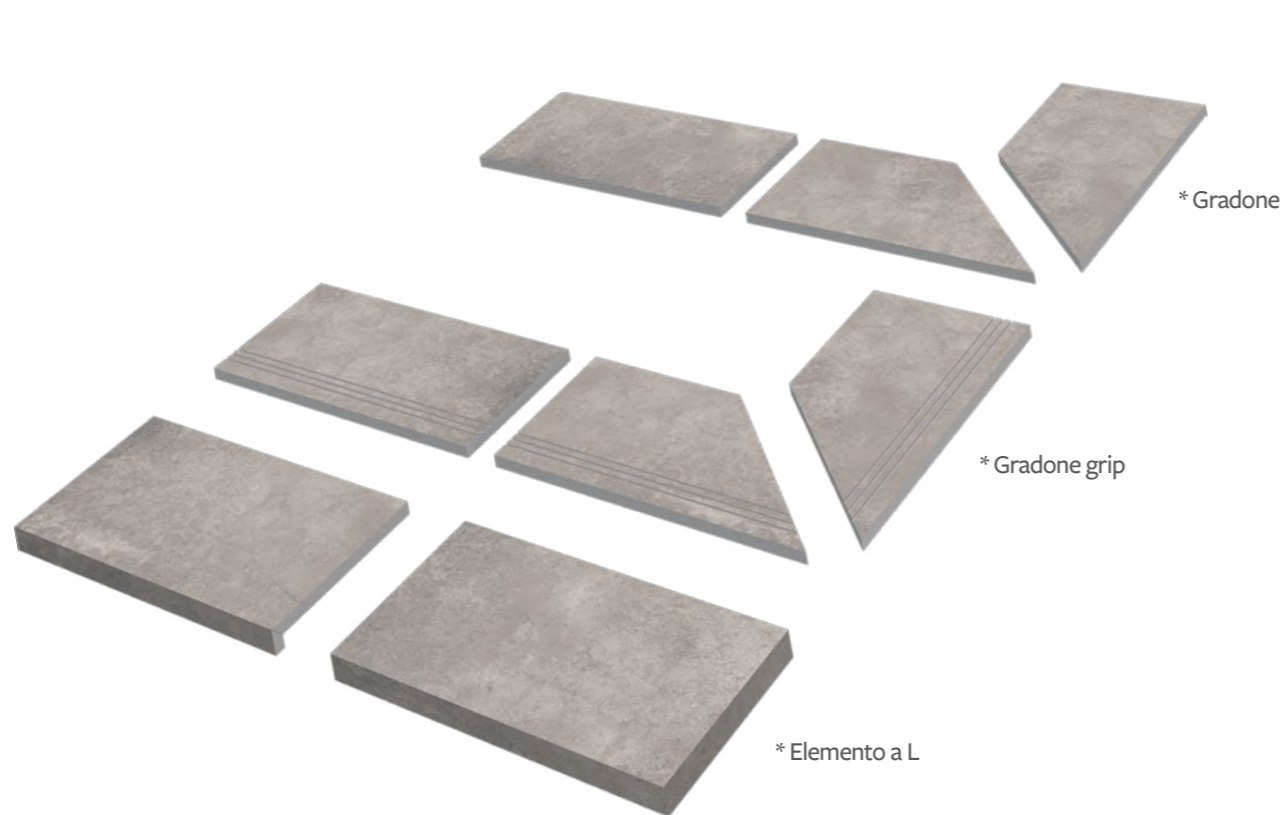
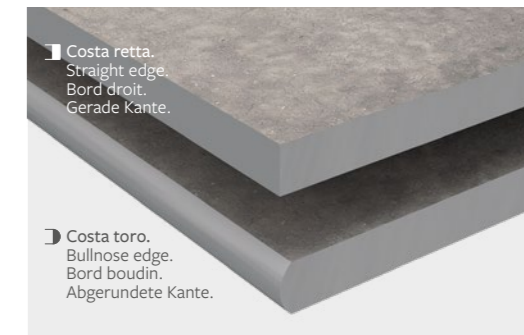

 * Gradone 30x120 . 12"x48"	 * Ang. Gradone - SX 30x120 . 12"x48"	 * Ang. Gradone - DX 30x120 . 12"x48"
 * Gradone grip 30x120 . 12"x48"	 * Ang. Gradone grip - SX 30x120 . 12"x48"	 * Ang. Gradone grip - DX 30x120 . 12"x48"
 * Elemento a L 33x120x4h . 13"x48"x1 1/2"h	 * Elemento a L SX 33x80x4h . 13"x31 1/2"x1 1/2"h	 * Elemento a L DX 33x80x4h . 13"x31 1/2"x1 1/2"h

 * Gradone bordo piscina 30x120 . 12"x48"	 * Ang. Gradone bordo piscina - SX 30x120 . 12"x48"	 * Ang. Gradone bordo piscina - DX 30x120 . 12"x48"
 * Gradone grip bordo piscina 30x120 . 12"x48"	 * Ang. Gradone grip bordo piscina - SX 30x120 . 12"x48"	 * Ang. Gradone grip bordo piscina - DX 30x120 . 12"x48"
 * Gradone svasato bordo piscina 30x120 . 12"x48"	 * Ang. Gradone svasato bordo piscina - SX 30x120 . 12"x48"	 * Ang. Gradone svasato bordo piscina - DX 30x120 . 12"x48"
 * Griglia 20x60 . 8"x24"	 * Griglia SX 20x60 . 8"x24"	 * Griglia DX 20x60 . 8"x24"

Per maggiori informazioni su imballi e codici articolo dei PEZZI SPECIALI 20 mm R11 e sui SUPPORTI PER PAVIMENTAZIONI SOPRAELEVATE, potete consultare il nostro BOOK (anche da sito internet, nell'area "download").
For more information on packaging and item codes of SPECIAL PIECES 20 mm R11 and on SUPPORTS FOR RAISED PAVING SYSTEM, please refer to our BOOK (also available for download on our website, in the "download" area).
Pour plus d'informations sur les emballages et les codes des PIÈCES SPÉCIALES 20 mm R11 et sur les SUPPORTS POUR LES SYSTÈMES DE CARRELAGES SURÉLEVÉS, consultez notre BOOK (sur notre site, section "téléchargement").
Weitere Informationen zu Verpackungen und Artikelcodes FORMTEILE IN 20 mm R11 und STELZLAGERN FÜR DOPPELBODEN finden Sie in unserem BOOK (auch auf der Website, im Bereich "Download").

* I tempi di consegna di tutti i pezzi speciali mostrati in queste pagine sono di 30 giorni dalla data dell'ordine.
Delivery time for all the special pieces shown on these pages are generally 30 days from order date.
La livraison de toutes les pièces spéciales présentés dans les pages du catalogue sont disponible 30 jours à compter de la date de commande.
Der Liefertermin fuer die Spezialteile, die in dieser Seite aufgeführt sind, beläuft sich auf 30 Tage nach Auftragsingang.

□ Naturale e rettificato.
Natural rectified.
Naturel et rectifié.
Natur Oberfläche und rektifiziert.

Suggerimenti per abbinare colori e stili Tagina

Tips for Matching Colours and Tagina Styles.

Conseils pour faire correspondre les couleurs et les styles Tagina.

Tipps für die Kombination von Tagina-Farben und -Stilen.

CONCRETE & DESIGN



MARBLE & ONYX



WOOD



	BIANCO	CENERE	BEIGE	SABBIA
PIETRA D'ORVIETO PIETRA DI LUNA	 ARGENT NOIR	 ARGENT ARGENT	 ARGENT ARGENT	 ARGENT ARGENT
PIETRA D'ORVIETO FULL COLOURS	 SHADOW	 SHADOW SHADOW	 SHADOW SHADOW	 SHADOW SHADOW
PIETRA D'ORVIETO CALACATTA GOLD			 CALACATTA GOLD	
PIETRA D'ORVIETO PATAGONIA	 CASHMERE	 TURCHESE	 CAFFÈ	 BIANCO CAFFÈ ZAFFIRO BIANCO
PIETRA D'ORVIETO SEGESTA			 CARAMEL	 CARAMEL
PIETRA D'ORVIETO EVOQUE	 DOUSSIE	 BAHIA	 KORINA	 DOUSSIE
Colore consigliato per la Fuga Recommended joint colour. Couleur d'échappement recommandée. Empfohlene Farbe für die Fuge.	 RAL 9016 NCS 0502-G50Y	 RAL 7030 NCS 4502-Y	 RAL 9002 NCS 1002-G50Y	 RAL 7044 NCS 2005-Y20R

Per le condizioni generali di vendita e le caratteristiche tecniche consultare www.tagina.it
General terms and Sales conditions and Technical features are available on our website www.tagina.it
Les Conditions général de vente et les Caractéristiques techniques sont disponibles sur le site web www.tagina.it
Allgemeine Verkaufsbedingungen und technische Eigenschaften sind auf unsere Website verfügbar: www.tagina.it

Tagina S.p.A. si riserva di modificare, senza alcun preavviso, il packaging dei prodotti, le grafiche, i colori e i decori riportati nelle immagini che sono pertanto da ritenersi indicative.
Tagina S.p.A. reserves the right to change the product packaging, the patterns, colours and decorations shown in the pictures without any prior notice. These aspects, therefore should be considered for illustrative purposes only.
Tagina S.p.A. se réserve le droit de modifier, sans préavis, l'emballage des produits, les graphismes, les couleurs et les décors représentés dans les images, fournies à titre indicatif.
Die Tagina S.p.A. behält sich vor, die Verpackung der Produkte, die in den Abbildungen gezeigten Grafiken, Farben und Dekors sowie ohne vorherige Ankündigung zu ändern.



PULIZIA E MANUTENZIONE DEL PRODOTTO

Product cleaning and maintenance
Nettoyage et entretien du produit
Reinigung und Wartung des Produkts



Follow us





Tagina S.p.A.
Via Emilia Ponente, 925
48014 Castel Bolognese (RA) - Italy
Tel. +39 0545 197 7303

tagina.it -  **DAFIN** GROUP